CHESTERTON CONNECT™ USER GUIDE

Intrinsically Safe Certified

Equipment Monitoring Sensor – Vibration, Temperature, and Pressure



TABLE OF CONTENTS

| | |
|---|-------|
| <i>Explanation of symbols</i> | 2 |
| <i>Warning and cautions</i> | 2 |
| <i>About the Chesterton Connect™ sensor</i> | 3 |
| <i>About the Chesterton Connect™ app</i> | 3 |
| <i>Specifications and limits</i> | 4 |
| <i>Software features</i> | 4 |
| <i>Certifications</i> | 4 |
| <i>Operating parameters</i> | 4 |
| <i>Statements</i> | 4 |
| <i>Sensor details</i> | 5 – 6 |
| <i>Components</i> | 5 |
| <i>LED alert system pattern</i> | 5 |
| <i>Vibration axes</i> | 6 |
| <i>Dimensions</i> | 6 |
| <i>Installation instructions</i> | 7 |
| <i>Tools required</i> | 7 |
| <i>Installation</i> | 7 |
| <i>Troubleshooting</i> | 8 |
| <i>Battery replacement</i> | 8 |
| <i>Power cycling</i> | 8 |
| <i>Factory resetting</i> | 8 |
| <i>Limited warranty</i> | 9 |
| <i>Privacy policy</i> | 9 |

Please read this user guide in its entirety before proceeding with the installation of the sensor. It is assumed that the user is familiar with the equipment and will take all the necessary safety precautions before attempting to install this sensor and its components. Caution must be taken to install the product using safe and best practice methods.

Explanation of symbol



WARNING!

Used to indicate warning. When not adhered to, may result in damage, injury, or the loss of the type of approval permit



CAUTION!

Used to indicate caution where there is a risk of damage to equipment.

Warnings and cautions



WARNING!

Replace cells only with a Tekcell SB-D02 cell in a non-hazardous area.



WARNING!

The installer must make adequate arrangements in the installation in order to ensure that the main body and its contents are maintained in the ambient temperature range of the equipment.



WARNING!

The plastic enclosure is a potential electrostatic hazard. Clean only with a damp cloth and do not mount equipment directly in a high velocity dust laden atmosphere where the dust can flow over the equipment enclosure. This will prevent the build-up of electrostatic charge on the external surface of the equipment enclosure.



CAUTIONS

- Chesterton Connect contains a replaceable lithium thionyl chloride battery and a neodymium magnet. Follow local laws for proper treatment and disposal of this product or its components.
- Chesterton Connect contains a very strong neodymium magnet. Use caution when handling unit to avoid injuries.
- Disable the product if it is damaged or operates incorrectly.
- Do not stick anything into the pressure/temperature 1/4" NPT port.
- Handle the unit using the supplied ESD protective caps until ready to install.
- Make sure product is used as specified and within its advertised operating limits.
- Do not bend cable beyond its bend radius.
- Do not allow the pressure/temperature sensor to come in contact with the magnet.
- Do not drop magnet against hard surfaces, including the pump.
- Do not drop the Chesterton Connect product. Dropping the product may affect its ability to function properly.
- Follow all nearby Personal Protective Equipment (PPE) and equipment safety requirements when installing, troubleshooting or removing the sensor and its components.
- If using the Pressure/Temperature (P/T) sensor, ensure the process fluid is compatible with the stainless-steel P/T sensor.
- Do not expose cable to corrosive environments as this may affect its ability to function properly.

About the Chesterton Connect™ sensor

Chesterton Connect is a 24/7 conditioning monitoring system that enables users to monitor process and equipment operating conditions. Chesterton Connect makes it simple and easy to monitor:

- 3-axis vibration
- Process temperature
- Surface temperature
- Process pressure

Chesterton Connect is aimed at equipment performance optimization, helping prioritize which equipment needs attention. The mobile app and unit's LED indicator alert the user of any vibration, temperature or pressure variations from the user programmed parameters. These alerts can help establish more efficient maintenance plans to help reduce unplanned downtime and asset failure.

About the Chesterton Connect™ app

Chesterton Connect communicates via Bluetooth with its companion mobile app to display alerts and measured data. The Chesterton Connect app is a user-friendly mobile application that allows the user to visualize the data collected from the sensor. In addition, the app allows the user to connect to multiple sensors providing a comprehensive view of a plant's equipment health. The app lets the user set equipment parameters limits. The data can be exported for analysis helping the user understand the equipment's operation and take preventative actions to extend productivity.

Software requirements (operating system):

- Android version 6.0 and up
- Apple version 10 and up
- Bluetooth version 4.0 and up

The Chesterton Connect app is available as a free download:



Specifications and limits

SOFTWARE FEATURES

- **Security:** Encrypted setup and password protected operation
- **Personalization:** Configurable name and usage information
- **Data acquisition:** Monitoring mode for extended battery life (5-minute intervals) and high accuracy mode for troubleshooting (1 minute intervals)
- **Data storage:** Up to 30 days of rolling history
- **Alerts:** Configurable thresholds, alarms
- **Analytics:** Time plotted trends and analysis
- **Data export:** Email export of sensor data and alarms

OPERATING PARAMETERS

- **Pressure sensor limit:** -1 bar g – 68 bar g (-14.7 psig – 1000 psig)
- **Temperature limit (body):** -20°C – 85°C (-4°F – 185°F)
- **Temperature limit (sensor):** -20°C – 125°C (-4°F – 257°F)
- **Vibration sensor:** 3-axis accelerometer ±16g
- **Battery:** 3.6V lithium thionyl chloride battery (replaceable)
- **Fitting:** 1/4" NPT 316SS connection
- **Mount:** Magnetic mounting base (additional mounting options sold separately)

CERTIFICATION

Model No.: 403699

Certifications: FCC, IC, CE, RoHS, IP66, NSF61, ACS

| Hazardous Ratings | |
|-------------------|---|
| ATEX/IECEX | ⊕ II 1 G Ex ia IIB T4 Ga |
| | ⊕ II 1 D Ex ia IIIB T ₂₀₀ 166°C Da |
| Zone | Class I Zone 0 AEx ia IIB T4 Ga |
| | Zone 20 AEx ia IIIB T166°C Da |
| Division | Class I Div 1 Groups C D T4 |
| | Class II Div 1 Groups F G T4 |
| Rated Temp | -20°C ≤ Ta ≤ +85°C |



Statements

FCC Compliance Statement

This device complies with Part 15 of the FCC Rules. Operation is subject to the following two conditions:

- (1) *this device may not cause harmful interference, and*
- (2) *this device must accept any interference received, including interference that may cause undesired operation. No changes shall be made to the equipment without the manufacturer's permission as this may void the user's authority to operate the equipment. This device has been designed and complies with the safety requirements for portable RF exposure in accordance with FCC rule part 2.1093 and KDB 447498 D01.*

RSS Compliance Statement

This device complies with Industry Canada's license-exempt RSSs. Operation is subject to the following two conditions:

- (1) *This device may not cause interference; and*
- (2) *This device must accept any interference, including interference that may cause undesired operation of the device. This device has been designed and complies with the safety requirement for RF exposure in accordance with RSS-102, issue 5 for portable conditions.*

EN 61326-1:2013 Radiated Immunity: Unit may experience temporary loss of function during interference.

Country of Origin: Assembled in the USA with domestic and international parts.

Sensor details

COMPONENTS

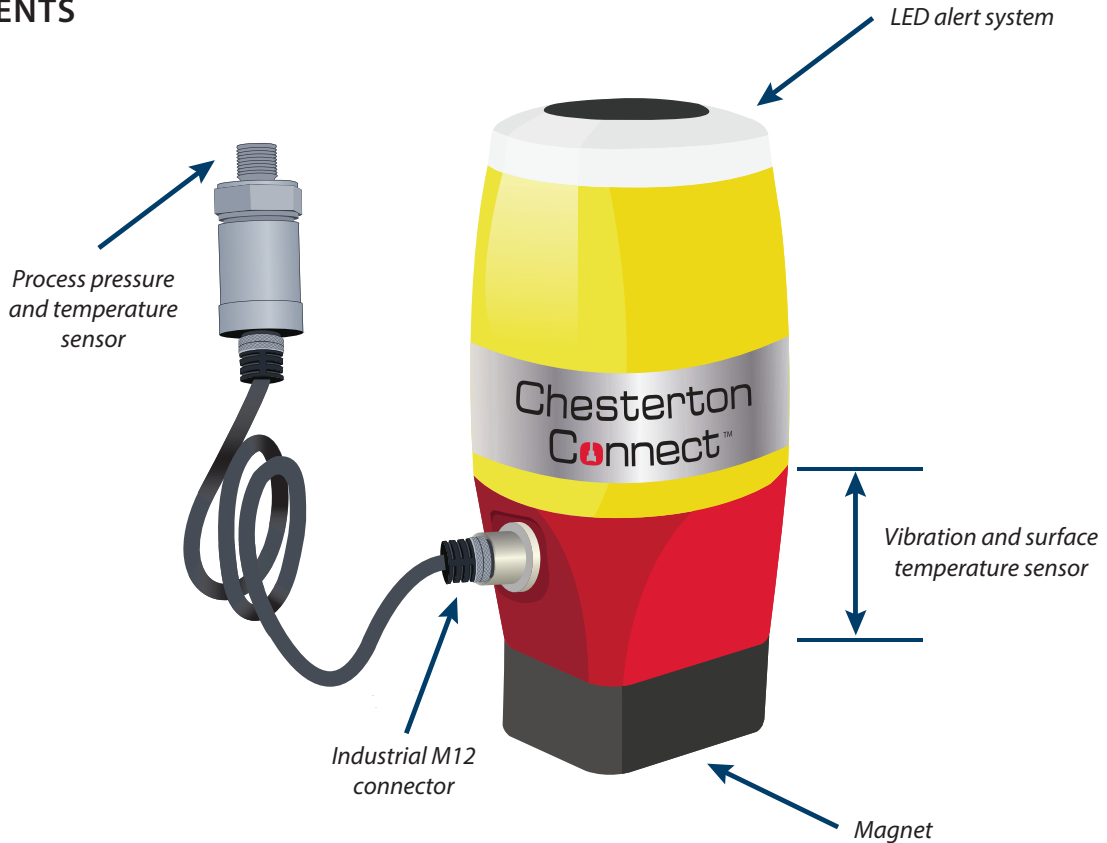







Figure 1a

LED ALERT SYSTEM PATTERN

| LED color | Alarm type |
|---|---|
|  +  +  | Powered on and operating correctly |
|  | <ul style="list-style-type: none"> • Mobile app connection to the sensor • Data "SYNC" • Sensor "identify" |
|   15 second intervals | Measurement outside established limits set by user |

Sensor details (continued)

DIMENSIONS

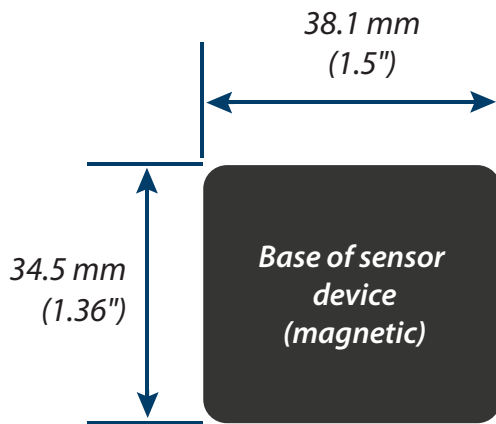
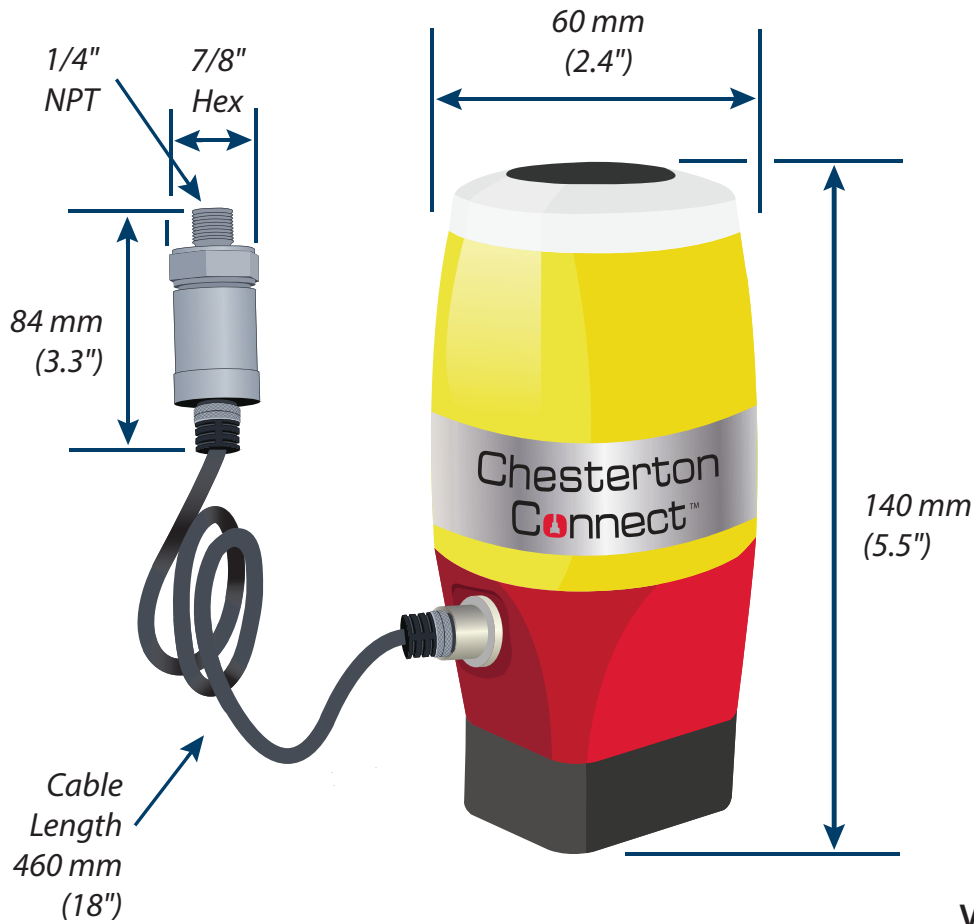

Figure 2

VIBRATION AXES

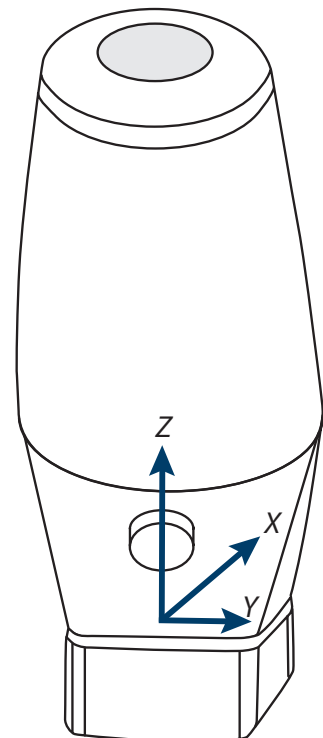

Figure 1b

Installation instructions

TOOLS REQUIRED



Thread sealant tape

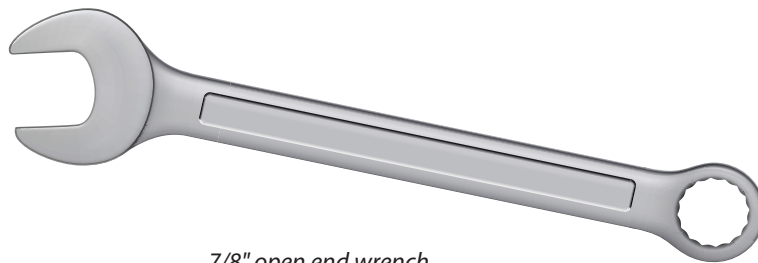

7/8" open end wrench

INSTALLATION



CAUTION!

The magnet is strong, attach at a 45° angle then flatten to the surface. Do not "drop" the magnet to the pump.

1. If using the Pressure/Temperature (P/T) sensor, ensure the process fluid is compatible with the stainless steel P/T sensor.* In addition, ensure process fluid temperature and pressure are within specified sensor limits (see page 3 for P/T sensor specifications limits). Follow the applicable lock out/tag out procedure for the equipment and make sure all PPE and safety precautions are followed.

Apply thread sealant to the 1/4" NPT connector. The 1/4" NPT connector can be installed on the:

- Pump suction
- Pump discharge
- Tee into double mechanical seal barrier or buffer fluid
- Connected to extra flush port or tee into flush of pump or mechanical seal

Tighten the 1/4" NPT 1.5 to 3 Turns From Finger Tight (T.F.F.T.) or approximately 25 ft-lb (see figure 3). *Note: Torque depends on different parameters such as sealing material, mating material, thread lubrication and pressure level.*

2. Attach the M12 pin connector to the base unit** (this will activate the unit). Turn the connector nut until it is finger tight. The LED alert system will flash red, green, blue, and green (again) when activated.
3. The base of the unit is magnetic. Install the unit on the surface where vibration and surface temperature will be measured*** (see figure 4 for preferred sensor location on pumps). Take care in selecting a safe stationary location to mount the unit. Ensure the operating temperatures do not exceed the rated temperature of the body 85°C (185°F).

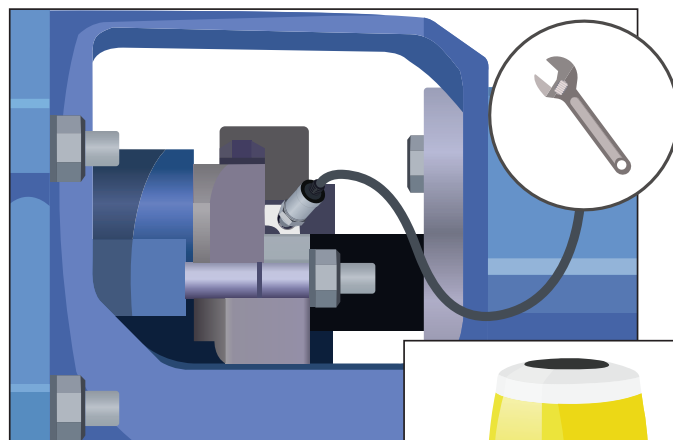

Figure 3

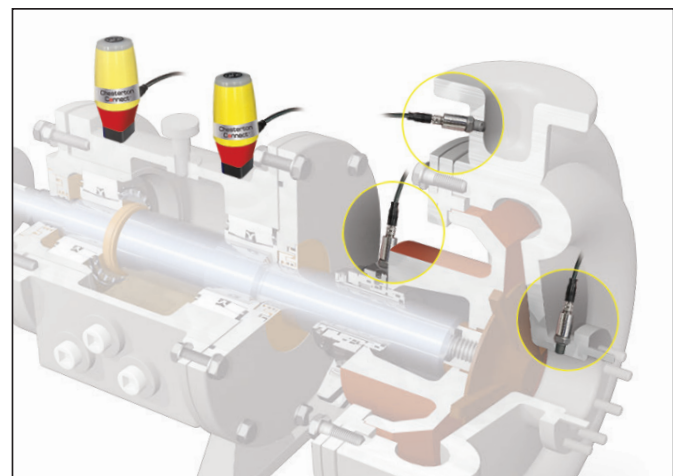

Figure 4

* Pressure port is a dead-ended component and must be inspected as part of the plant's maintenance plan to ensure no debris, slurry, or solidified process clogs the pressure port in the sensor head.

** An extension cable (sold separately) can be added to the P/T sensor. Only 1 (one) extension cable is recommended per sensor. For applications requiring additional extension cables please contact our customer support (see page 8)

***It is recommended in critical applications, additional tethers or attachment methods be used to ensure the telemetry head stays attached to the equipment.

Troubleshooting

BATTERY REPLACEMENT



WARNING!

Clean only with a damp cloth and replace battery only with Tekcell SB-D02 in a non-hazardous area.

App will indicate when the battery is low, to replace the battery:

1. Disconnect the M12 pin connector from the unit.
This will deactivate the unit. Ensure P/T cable is safely secured.
2. Move the unit to a clean and dry location.
3. Once in a clean and dry location, unscrew top housing.
4. Remove the battery protection covers. Remove the old battery. Follow local laws for proper disposal of the old battery.
5. Insert the replacement battery positive side up (see figure 5). Replace only with Chesterton battery, item number 403683.

6. Re-attach the protection covers and the top housing until it is finger tight.
7. Re-attach the M12 pin connector to the base unit. This will reactivate the unit. Turn the connector nut until it is finger tight. The unit will flash red, green, blue and green (again) when activated.

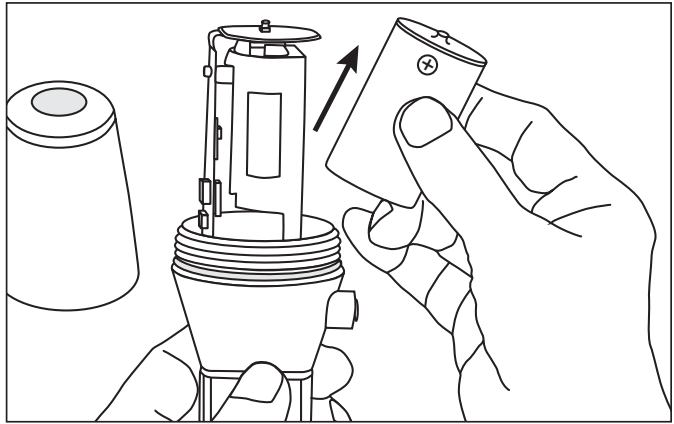

Figure 5

POWER CYCLING

Power cycling is a useful method to diagnose your sensor's operation. The unit's LED alert system will flash red, green, blue, and green (again) after performing a successful power cycle.

1. Disconnect the M12 pin connector from the unit. This will deactivate the unit. Ensure the P/T cable is safely secured.
2. Wait 5 seconds.

3. Reconnect the M12 pin connector to the unit. This will activate the unit. Turn the connector nut until it is finger tight.

Note: If the unit's LED alert system does not flash red, green, blue, and green (again) after performing a power cycling contact customer support on page 8.

FACTORY RESETTING

A factory reset deletes all measured data stored in the unit.

To factory reset your sensor, the **M12 pin connector must stay connected**. Factory resetting shall only be performed in a clean and dry location. Avoid contact with any liquids or contaminants.

1. Once in a clean and dry location, unscrew top housing.
2. Press and hold the top "Reset" button down for 15 seconds (see figure 6). The LED will flash red and green.
3. After the LED flashes, release the "Reset" button.
4. Re-attach the top housing and turn until it is finger tight.

If you forget your password you can reset the sensor; however you will lose all measured data stored in the unit.

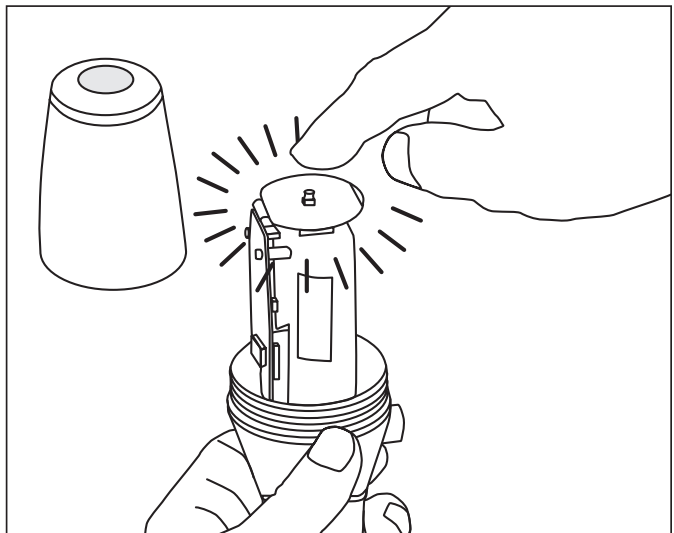

Figure 6

Limited warranty

Chesterton warrants, for a period of one year from the original date of shipment, that its Chesterton Connect™ sensor (the "Product") will be delivered free from defects in material and workmanship. Improper use of the Product, including but not limited to failure to follow instructions and warnings stated in the User Guide, accident, neglect, or abuse of the Product, or modifying the Product will void this warranty. THIS LIMITED WARRANTY IS EXCLUSIVE AND IN LIEU OF ALL OTHER WARRANTIES BY CHESTERTON, EXPRESS OR IMPLIED; TO THE FULLEST EXTENT PERMITTED BY LAW, ALL IMPLIED WARRANTIES INCLUDING BUT NOT LIMITED TO WARRANTIES OF MERCHANTABILITY, FITNESS FOR A PARTICULAR PURPOSE, COMPLETENESS OR THAT THE PRODUCT WILL MEET CUSTOMER'S REQUIREMENTS, ARE HEREBY EXPRESSLY EXCLUDED TO THE MAXIMUM EXTENT PERMITTED BY APPLICABLE LAW. CHESTERTON DOES NOT WARRANT THAT THE OPERATION OF THE PRODUCT WILL BE UNINTERRUPTED, ERROR-FREE, OR HAVE IMPENETRABLE SECURITY. USE OF INFORMATION PROVIDED THROUGH THE APPLICATION IS SOLELY AT THE CUSTOMER'S OWN RISK. IN NO EVENT SHALL CHESTERTON BE LIABLE FOR ANY DECISION MADE OR ACTION TAKEN IN RELIANCE ON ANY INFORMATION MADE AVAILABLE BY, THROUGH, OR AS A RESULT OF THE PRODUCT.

If Customer notifies Chesterton of a potentially defective Product within the warranty period above, and that Product is determined by Chesterton to be defective, Chesterton will

at its option either repair, replace or refund the purchase price of that Product. Labor is not included. THE ABOVE REMEDY SHALL BE THE SOLE AND EXCLUSIVE REMEDY FOR ANY BREACH OF WARRANTY. CHESTERTON SHALL NOT BE LIABLE FOR ANY OTHER COSTS, LOSSES, EXPENSES, DAMAGES OR CONSEQUENTIAL DAMAGES INCLUDING, WITHOUT LIMITATION, ANY DAMAGES FOR LOSS OF BUSINESS OR LOSS OF PROFITS.

IN NO EVENT SHALL CHESTERTON BE LIABLE FOR ANY LOST PROFITS, LOSS OF DATA, OR BUSINESS INTERRUPTION, OR FOR ANY INDIRECT, SPECIAL, INCIDENTAL, PUNITIVE, EXEMPLARY, OR CONSEQUENTIAL OR SPECIAL DAMAGES OR LOST PROFITS HOWEVER CAUSED AND WHETHER IN CONTRACT, TORT OR UNDER ANY OTHER THEORY OF LIABILITY.

The Product is a special assembly of A.W. Chesterton Company's design which is certified for use in certain hazardous environments. To ensure your safety in hazardous environments, the external sensor, all other parts, and all accessories, including the special connector, should only be obtained through A.W. Chesterton Company. USE OF ANY PARTS OR ACCESSORIES NOT PROVIDED BY A.W. CHESTERTON COMPANY VOIDS ALL SAFETY CERTIFICATIONS, VOIDS ALL WARRANTIES, AND MAY BE DANGEROUS TO YOUR SAFETY AND/OR THE SAFETY OF YOUR FACILITY.

Privacy policy

To view Chesterton's privacy policy please visit:

<https://chesterton.com/en-US/Pages/Privacy.aspx>

For more information

Go to: [Chestertonconnect.com/product](https://chestertonconnect.com/product)

Email: connect.support@chesterton.com

Telephone: 833-677-7343

Telephone: +1 83 367 77343

Product does not include a mobile device.



860 Salem Street
Groveland, MA 01834 USA
Telephone: 781-438-7000
Fax: 978-469-6528
chesterton.com

© 2021 A.W. Chesterton Company
® Registered trademark owned by A.W. Chesterton Company in USA and other countries,
unless otherwise noted.

Chesterton Connect™ is a trademark of A.W. Chesterton Company. Technical data reflects results of laboratory tests and is intended to indicate general characteristics only. A.W. Chesterton Company disclaims all warranties express or implied, including warranties of merchantability and fitness for a particular purpose. Liability, if any, is limited to product replacement only. Any images contained herein are for general illustrative or aesthetic purposes only and are not intended to convey any instructional, safety, handling or usage information or advice respecting any product or equipment. Please refer to relevant Safety Data Sheets, Product Data Sheets, and/or Product Labels for safe use, storage, handling, and disposal of products, or consult with your local Chesterton sales representative.