

3656/3756LH

LOW HEAD, CAST IRON, BRONZE FITTED, END-SUCTION PUMPS

BOMBAS DE SUCCIÓN FINAL, PEQUEÑA CARGA, HIERRO FUNDIDO, RECUBIERTAS DE BRONCE

Commercial Water

A FULL RANGE OF PRODUCT FEATURES UNA GAMA TOTAL DE CARACTERÍSTICAS DEL PRODUCTO

The 3656LH and 3756LH pumps from Goulds Water Technology have been designed with technical benefits to meet the needs of both manufacturers and users in a variety of refrigeration and cooling applications as well as irrigation applications.

- Performance testing of every pump we manufacture assures trouble free operation.
- Back pull-out to reduce maintenance down time.
- Standard John Crane Type 21 mechanical seal for both reliability and availability.
- Available in all iron or bronze fitted construction for application versatility.
- Replaceable wearing components include stainless steel shaft sleeve and casing wear ring to maintain peak efficiency.
- Enclosed impeller design, dynamic balancing and renewable wear ring reduce losses affecting performance and pump life.
- Suction and discharge connections are NPT threaded except for the 4 x 4-5 and 5 x 5-6 sizes which have ANSI class 125 flat faced flanges.
- Casing mounting is standard with a vertical discharge however can be rotated in 90 degree increments for side discharge arrangements.

Las bombas 3656LH y 3756LH de Goulds Water Technology han sido diseñadas con beneficios técnicos para cumplir con las necesidades de fabricantes y usuarios en una variedad de aplicaciones para refrigeración y enfriamiento, además de aplicaciones de irrigación.

- *Pruebas de funcionamiento de cada bomba que fabricamos, aseguran un funcionamiento sin problemas.*
- *Extracción trasera para reducir el tiempo de mantenimiento.*
- *Sello mecánico estándar John Crane Tipo 21 para funcionalidad y disponibilidad.*
- *Disponibles en todas las construcciones de hierro o recubiertas de bronce para variedad de aplicaciones.*
- *Componentes reemplazables sujetos a desgaste incluyen camisas de eje de acero inoxidable y anillos de desgaste de la carcasa para mantener un rendimiento óptimo.*
- *Las conexiones de succión y descarga son NPT roscadas, excepto por los tamaños de 4 x 4-5 y 5 x 5-6 que tienen bridas de cara plana ANSI Clase 125.*
- *El montaje de la carcasa es estándar con una descarga vertical; sin embargo, se puede rotar en incrementos de 90 grados para disposiciones de descarga lateral.*

3656LH, 3756LH NUMBERING SYSTEM 3656LH, 3756LH SISTEMA DE NUMERACIÓN

The various versions of the 3656LH and 3756LH are identified by a product code number on the pump label. This number is also the catalog number for the pump. The meaning of each digit in the product code number is shown below.

Las diferentes versiones de las 3656LH y 3756LH se identifican con un número de código del producto en la etiqueta de la bomba. Este número es también el número de catálogo para la bomba. El significado de cada dígito en el número de código del producto se muestra abajo.

Example Product Code, Ejemplo Código del Producto

51 BF 1 F 2 B 0

Mechanical Seal and O-ring, Sello Mecánico y Anillo 'O'

Seal Code, Código del Sello	Rotary, Rotativo	Stationary, Estacionario	Elastomers, Elastómeros	Metal Parts, Partes Metálicas	Part No., Pieza Número
0		Ceramic, Cerámica	BUNA	Type 316 SS, Tipo 316 SS	10K13
1	Carbon	Sil-Carb.,	EPR		10K19
3		Caburo de silicón	Viton	Tipo 316 SS	10K27
5	Sil-Carb.				10K64

Note: 10K27 replaces obsolete 10K25,
Nota: La 10K27 reemplaza la obsoleta 10K25.

Impeller Option Code, Código del Impulsor Opcional

Impeller Code, Código del Impulsor	Pump Size, Tamaño de la Bomba				
	2 x 2 - 5	2 1/2 x 2 1/2 - 5	3 x 3 - 5	4 x 4 - 5	5 x 5 - 6
	Dia.	Dia.	Dia.	Dia.	Dia.
A	4"	4 3/16"	4 3/8"	4 3/4"	5 1/2 x 4 1/2"
B	3 3/4	3 1/16	4 3/16	4 3/8	5 3/16 x 4 3/16
C	3 1/2	3 3/4	4	4 1/2	5 x 3 3/8
D	3 1/4	3 9/16	3 13/16	4 3/16	5 x 3 9/16
E	3	3 3/8	3 3/8	4	5 x 3 1/32

Driver, Conductor

1 = 1 PH, ODP 6 = 575 V, TEFC
2 = 3 PH, ODP 7 = 3 PH, XP
3 = 575 V, ODP 8 = 575 V, XP
4 = 1 PH, TEFC 9 = 3 PH, TEFC, PREF.
5 = 3 PH, TEFC 0 = 1 PH, XP

HP Rating, HP Potencia

C = 1/2 E = 1 G = 2 J = 5 L = 10
D = 3/4 F = 1 1/2 H = 3 K = 7 1/2 M = 15

Driver: Hertz/Pole/RPM, Conductor: Hercios/Polo/RPM

1 = 60 Hz, 2 pole, 3500 RPM
2 = 60 Hz, 4 pole, 1750 RPM
3 = 60 Hz, 6 pole, 1150 RPM
4 = 50 Hz, 2 pole, 2900 RPM
5 = 50 Hz, 4 pole, 1450 RPM

Material

AI = All iron, Todo hierro
BF = Bronze fitted, Recubiertas de bronce

Pump Size, Tamaño de la Bomba

51 = 2 x 2 - 5 54 = 4 x 4 - 5
52 = 2 1/2 x 2 1/2 - 5 55 = 5 x 5 - 6
53 = 3 x 3 - 5

Replace with "FRM" for 3756LH
Reemplace con "FRM" para 3756LH

PERFORMANCE COVERAGE, ALCANCE DE FUNCIONAMIENTO

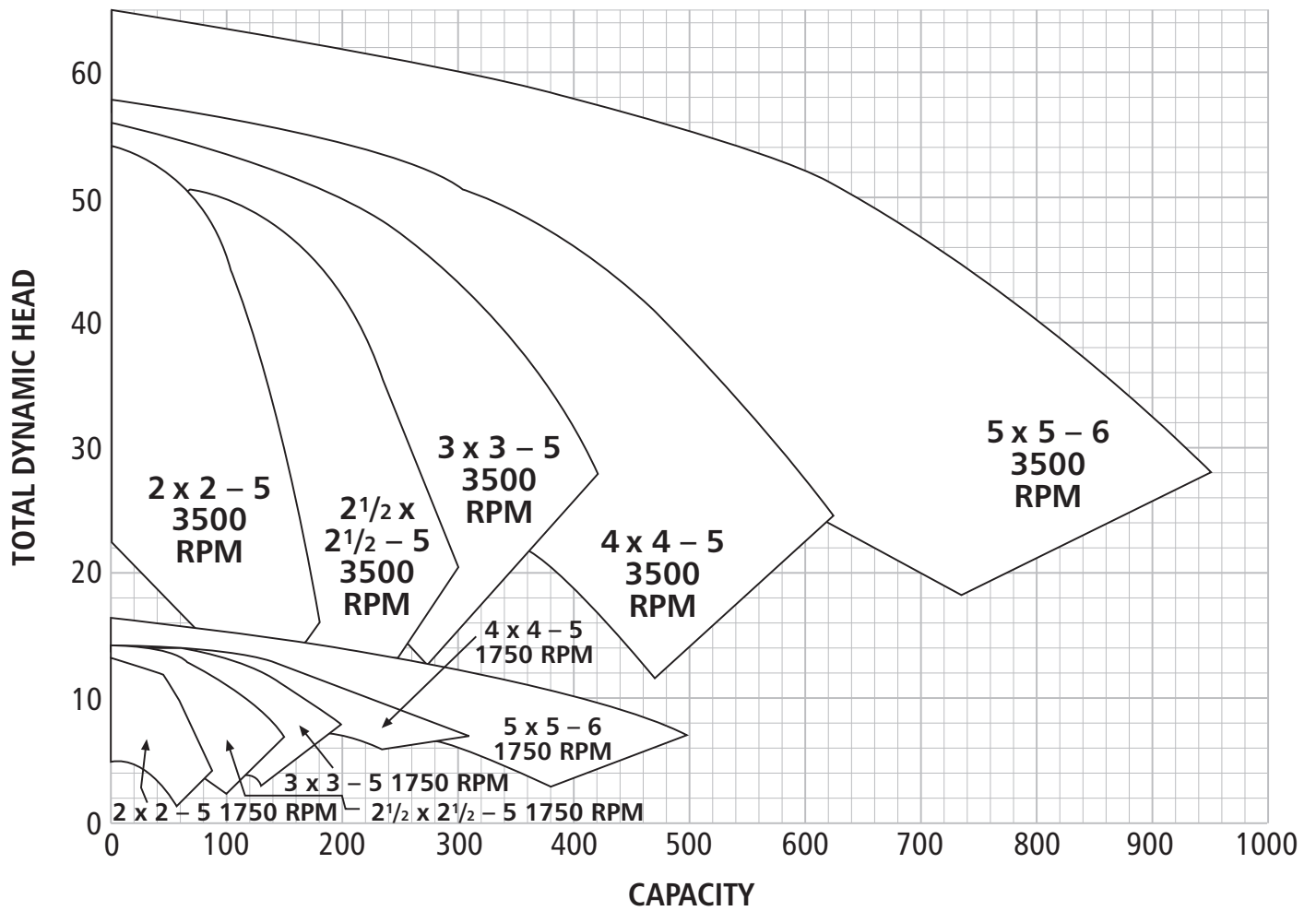

Commercial Water

PERFORMANCE CURVES, CURVAS DE FUNCIONAMIENTO

These curves show the performance of the three sizes of the 3656LH and 3756LH at 3500 RPM and 1750 RPM, 60 Hz, and 2900 RPM, 50 Hz. Standard impeller trims are shown.

Estas curvas muestran el rendimiento de los tres tamaños de la 3656LH y 3756LH a 3500 RPM y 1750 RPM, 60 Hz, y 2900 RPM, 50 Hz. Se muestran recortes estándar de impulsor.

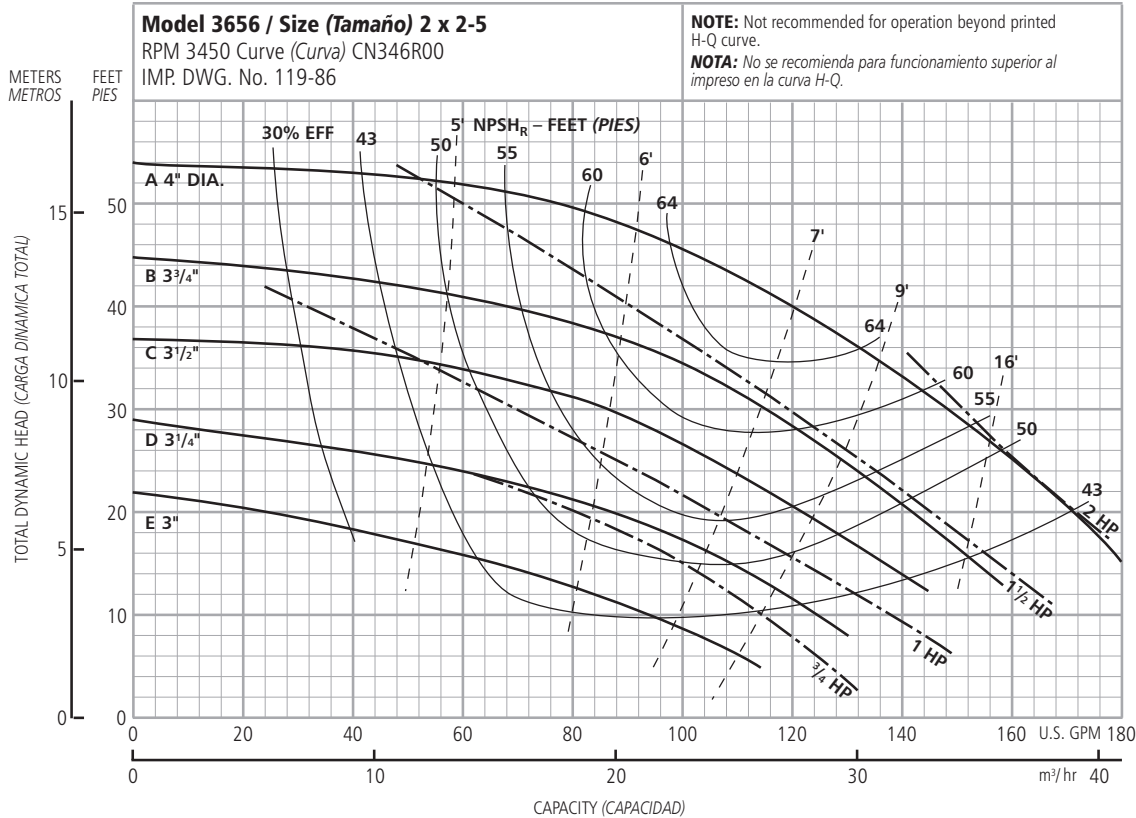

Optional Impeller Impulsor optativo	
Ordering Code Código de pedido	Dia. Diá.
A	4"
B	3 3/4"
C	3 1/2"
D	3 1/4"
E	3 1/4"

NOTE: Pump will pass a sphere to 3/32" diameter.
NOTA: La bomba dejará pasar una esfera de hasta 3/32 de pulgada de diámetro.

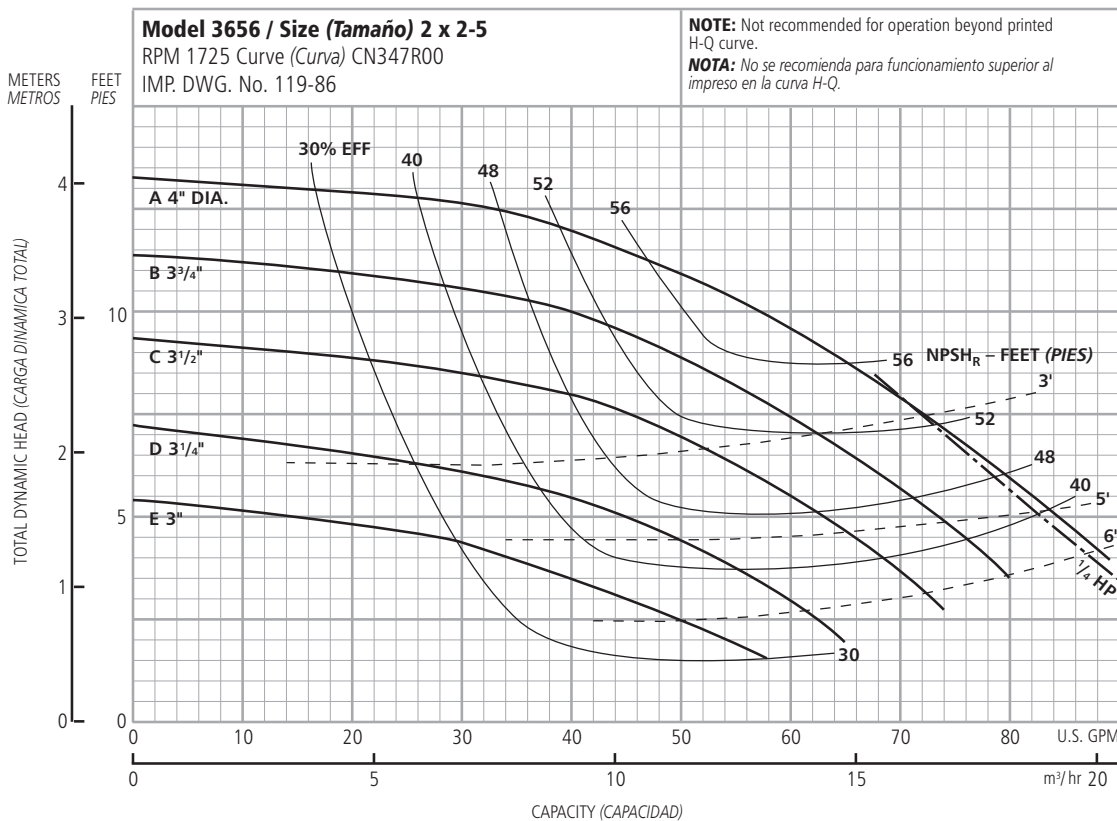

Optional Impeller Impulsor optativo	
Ordering Code Código de pedido	Dia. Diá.
A	4"
B	3 3/4"
C	3 1/2"
D	3 1/4"
E	3 1/4"

NOTE: Pump will pass a sphere to 3/32" diameter.
NOTA: La bomba dejará pasar una esfera de hasta 3/32 de pulgada de diámetro.

PERFORMANCE CURVES, CURVAS DE FUNCIONAMIENTO

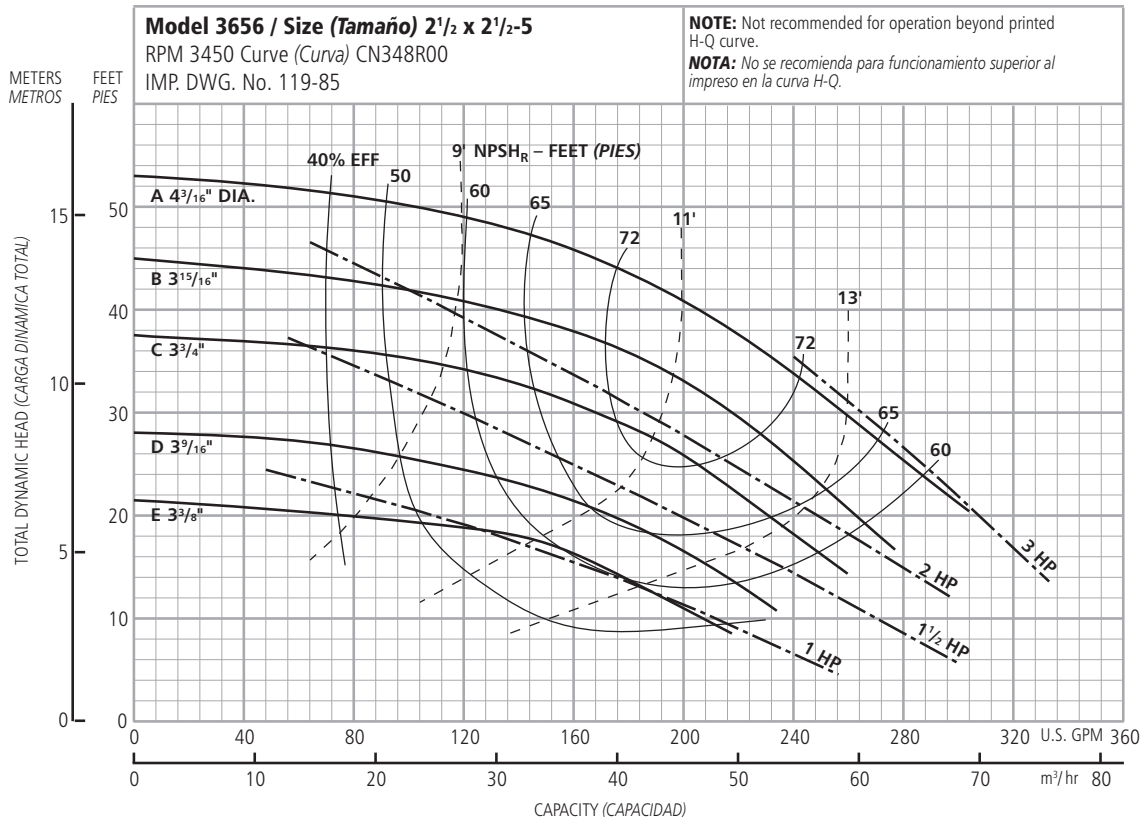

Optional Impeller Impulsor optativo	
Ordering Code Código de pedido	Dia. Diá.
A	4 3/16"
B	3 15/16"
C	3 3/4"
D	3 9/16"
E	3 3/8"

NOTE: Pump will pass a sphere to 5/32" diameter.
NOTA: La bomba dejará pasar una esfera de hasta 5/32 de pulgada de diámetro.

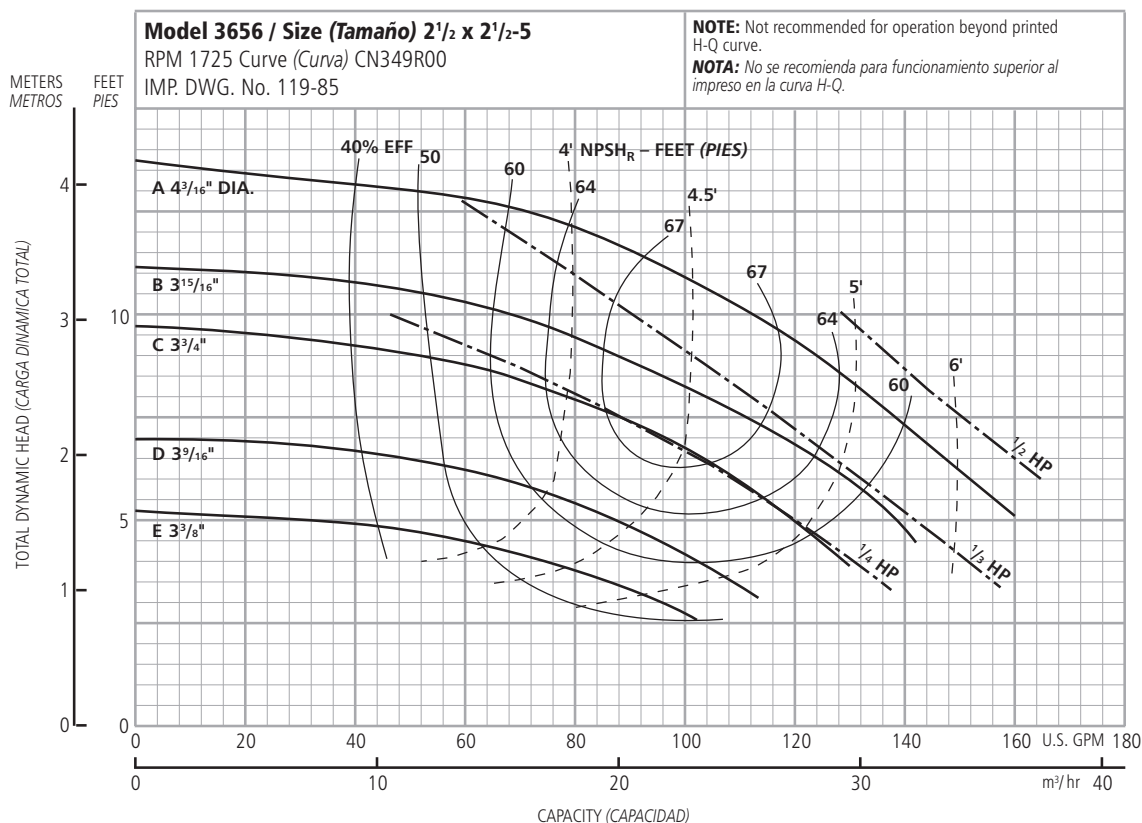

Optional Impeller Impulsor optativo	
Ordering Code Código de pedido	Dia. Diá.
A	4 3/16"
B	3 15/16"
C	3 3/4"
D	3 9/16"
E	3 3/8"

NOTE: Pump will pass a sphere to 5/32" diameter.
NOTA: La bomba dejará pasar una esfera de hasta 5/32 de pulgada de diámetro.

PERFORMANCE CURVES, CURVAS DE FUNCIONAMIENTO

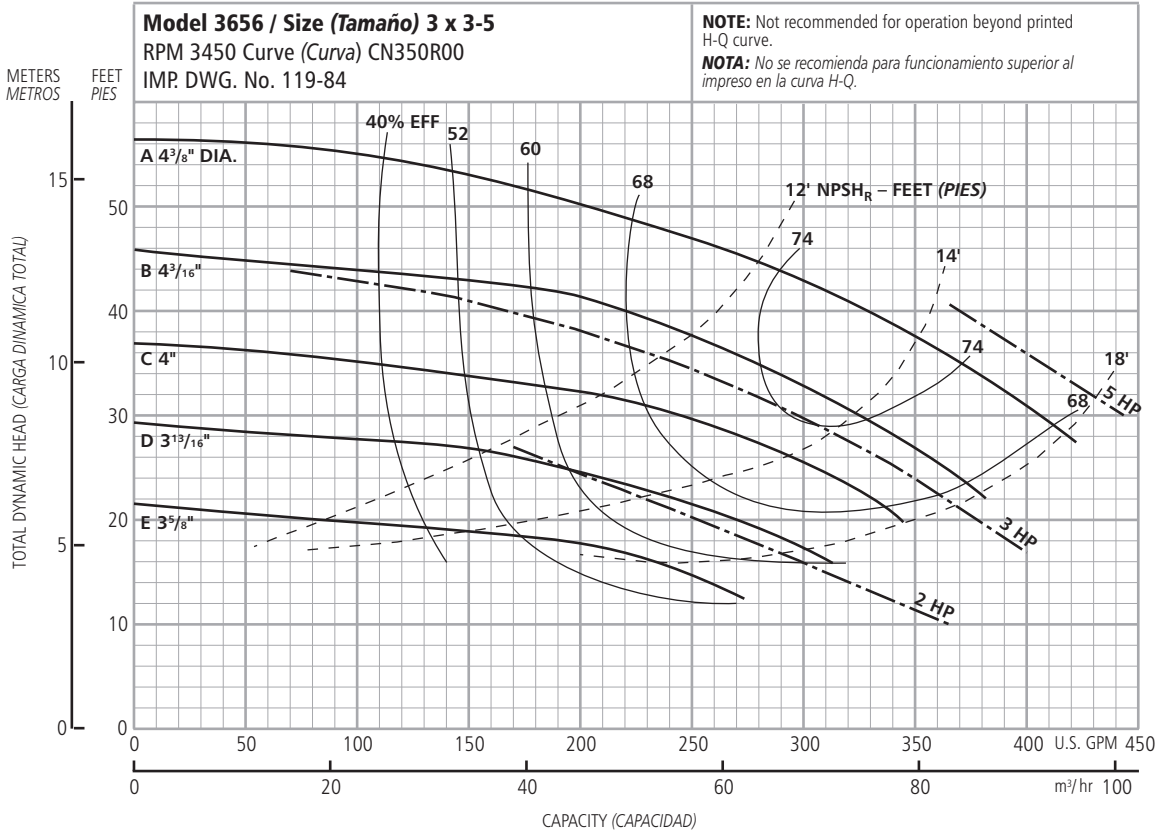

Optional Impeller Impulsor optativo

Ordering Code Código de pedido	Dia. Diá.
A	4 ³ / ₈ "
B	4 ³ / ₁₆ "
C	4"
D	3 ¹³ / ₁₆ "
E	3 ⁵ / ₈ "

NOTE: Pump will pass a sphere to ⁵/₃₂" diameter.
NOTA: La bomba dejará pasar una esfera de hasta ⁵/₃₂ de pulgada de diámetro.

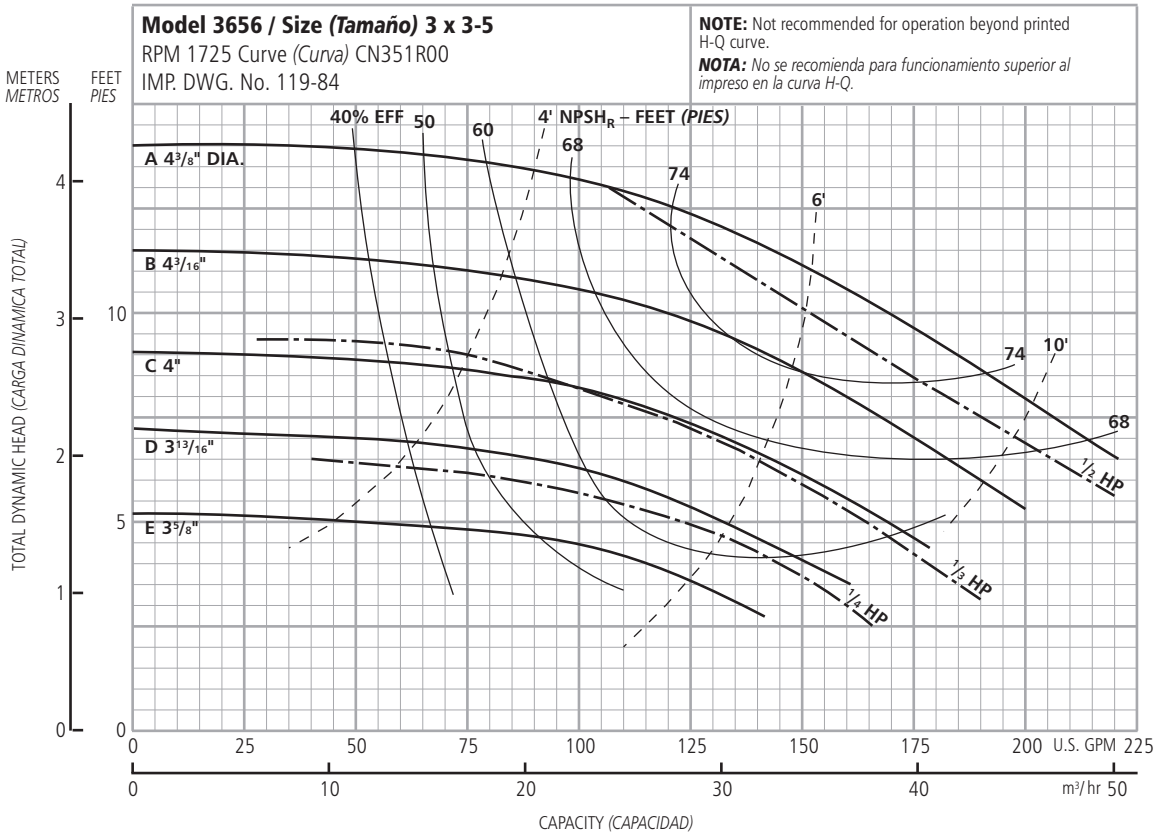

Optional Impeller Impulsor optativo

Ordering Code Código de pedido	Dia. Diá.
A	4 ³ / ₈ "
B	4 ³ / ₁₆ "
C	4"
D	3 ¹³ / ₁₆ "
E	3 ⁵ / ₈ "

NOTE: Pump will pass a sphere to ⁵/₃₂" diameter.
NOTA: La bomba dejará pasar una esfera de hasta ⁵/₃₂ de pulgada de diámetro.

Commercial Water

PERFORMANCE CURVES, CURVAS DE FUNCIONAMIENTO

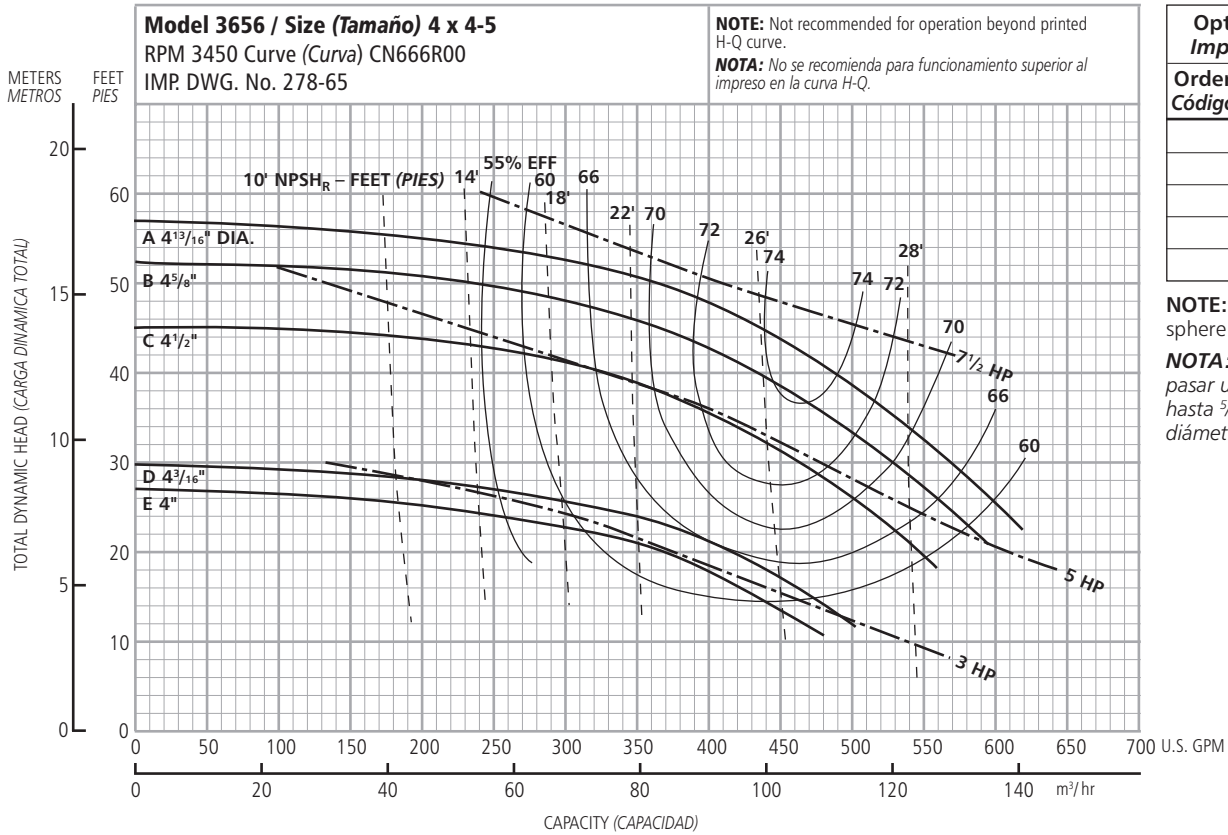

Optional Impeller Impulsor optativo	
Ordering Code Código de pedido	Diá. Diá.
A	4 ³ / ₄ "
B	4 ⁵ / ₈ "
C	4 ¹ / ₂ "
D	4 ³ / ₁₆ "
E	4"

NOTE: Pump will pass a sphere to ⁵/₃₂" diameter.
NOTA: La bomba dejará pasar una esfera de hasta ⁵/₃₂ de pulgada de diámetro.

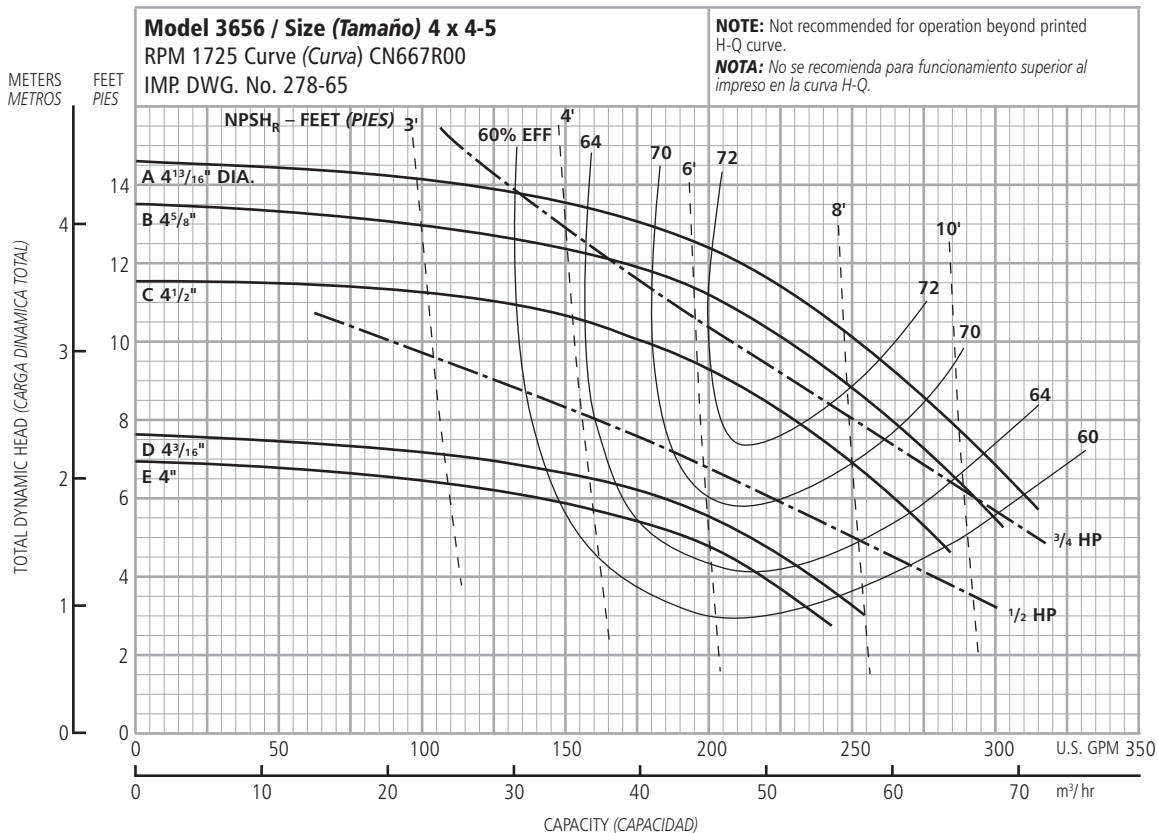

Optional Impeller Impulsor optativo	
Ordering Code Código de pedido	Diá. Diá.
A	4 ³ / ₄ "
B	4 ⁵ / ₈ "
C	4 ¹ / ₂ "
D	4 ³ / ₁₆ "
E	4"

NOTE: Pump will pass a sphere to ⁵/₃₂" diameter.
NOTA: La bomba dejará pasar una esfera de hasta ⁵/₃₂ de pulgada de diámetro.

PERFORMANCE CURVES, CURVAS DE FUNCIONAMIENTO

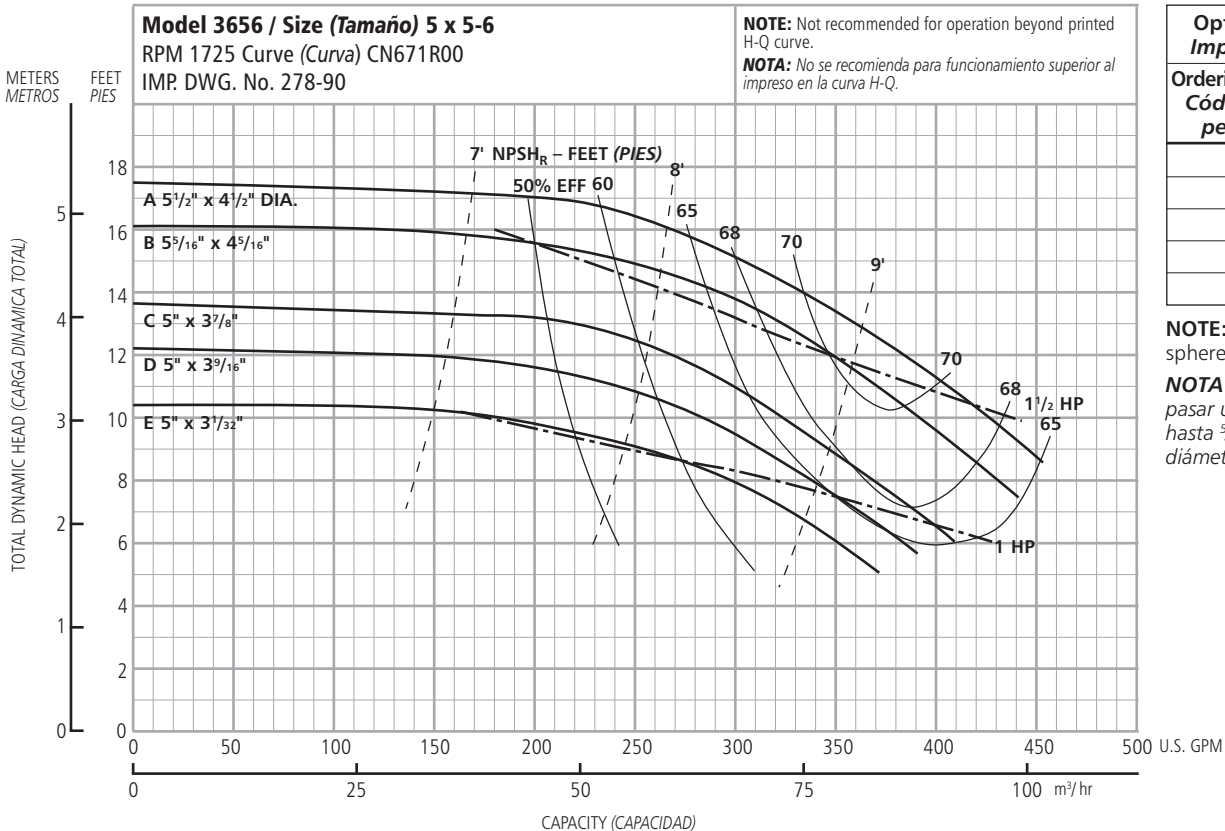
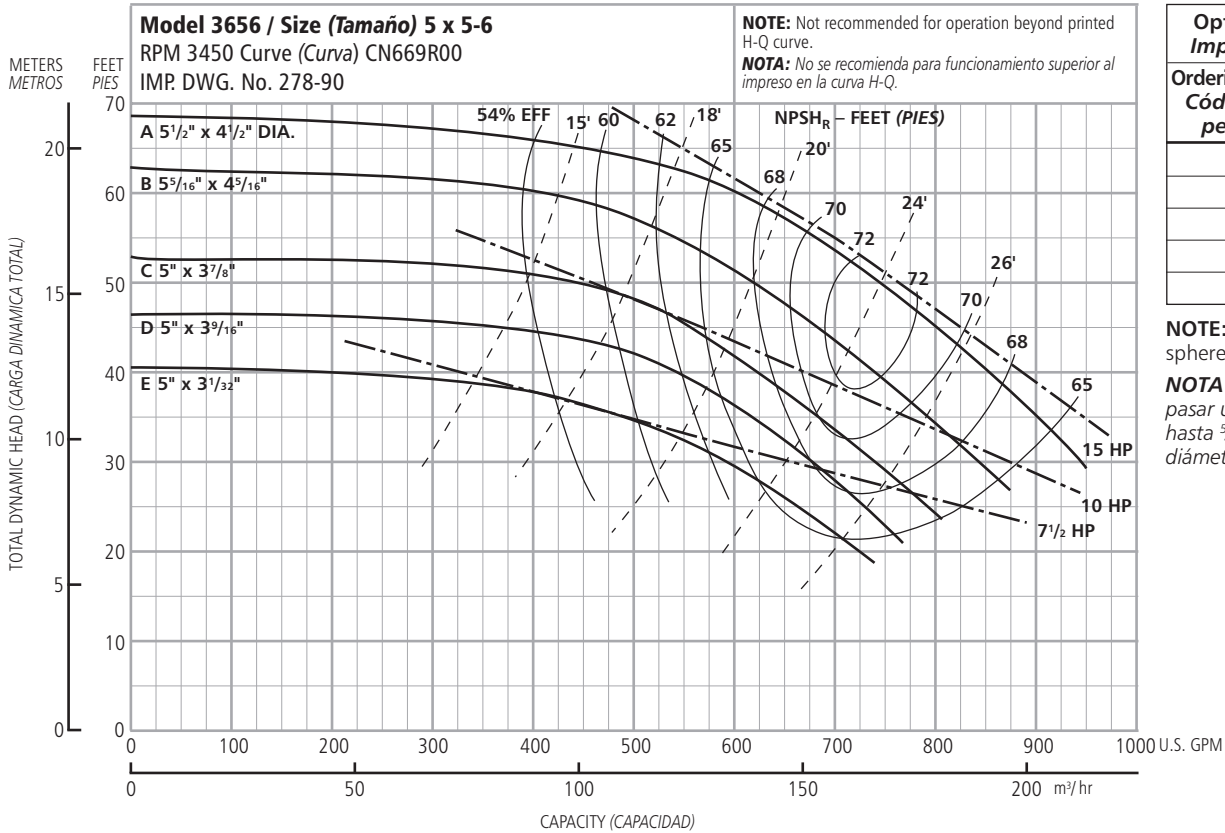

Commercial Water

PERFORMANCE CURVES, CURVAS DE FUNCIONAMIENTO

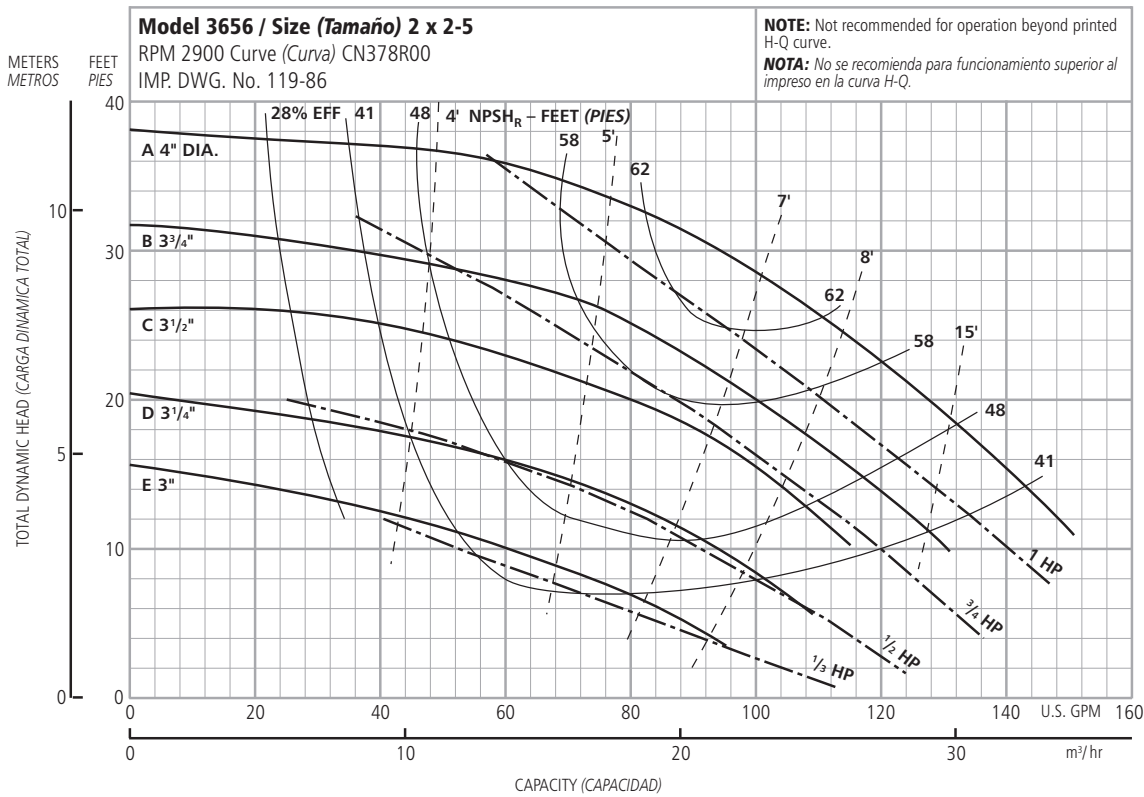

Optional Impeller Impulsor optativo	
Ordering Code Código de pedido	Dia. Diá.
A	4"
B	3 3/4"
C	3 1/2"
D	3 1/4"
E	3"

NOTE: Pump will pass a sphere to 5/32" diameter.
NOTA: La bomba dejará pasar una esfera de hasta 5/32 de pulgada de diámetro.

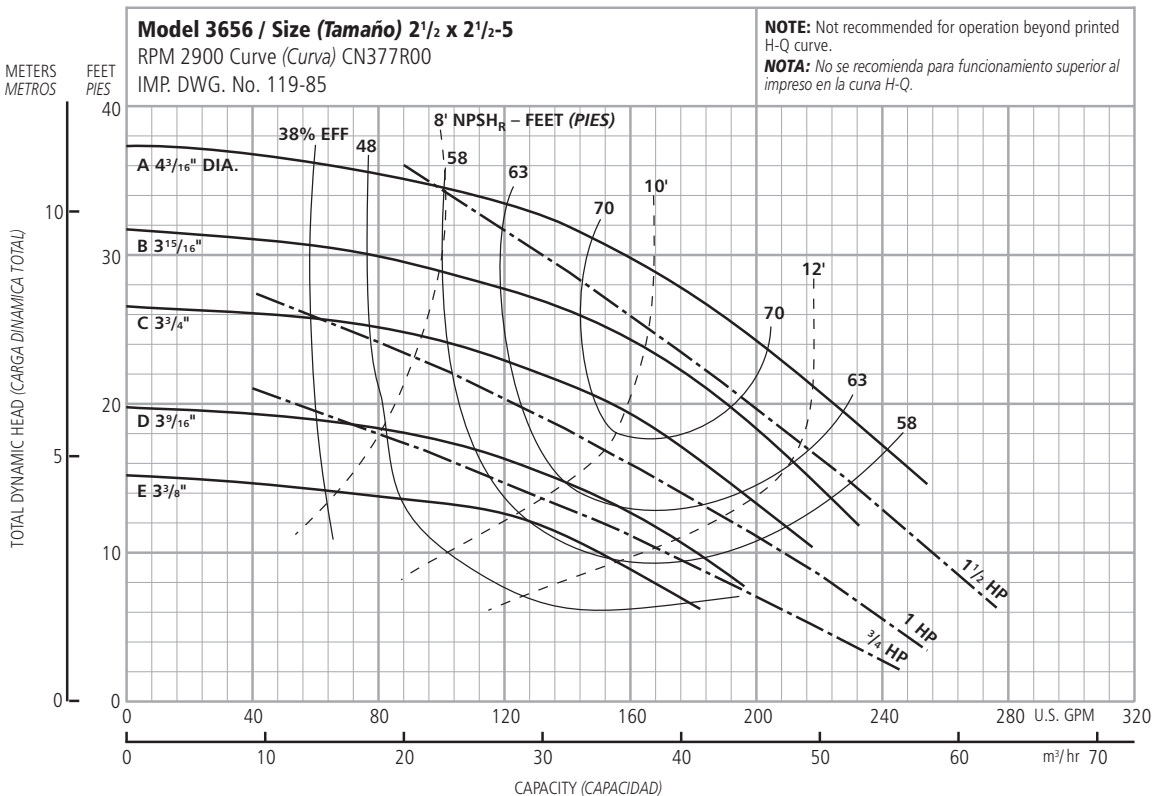

Optional Impeller Impulsor optativo	
Ordering Code Código de pedido	Dia. Diá.
A	4 3/16"
B	3 15/16"
C	3 3/4"
D	3 9/16"
E	3 7/8"

NOTE: Pump will pass a sphere to 5/32" diameter.
NOTA: La bomba dejará pasar una esfera de hasta 5/32 de pulgada de diámetro.

PERFORMANCE CURVES, CURVAS DE FUNCIONAMIENTO

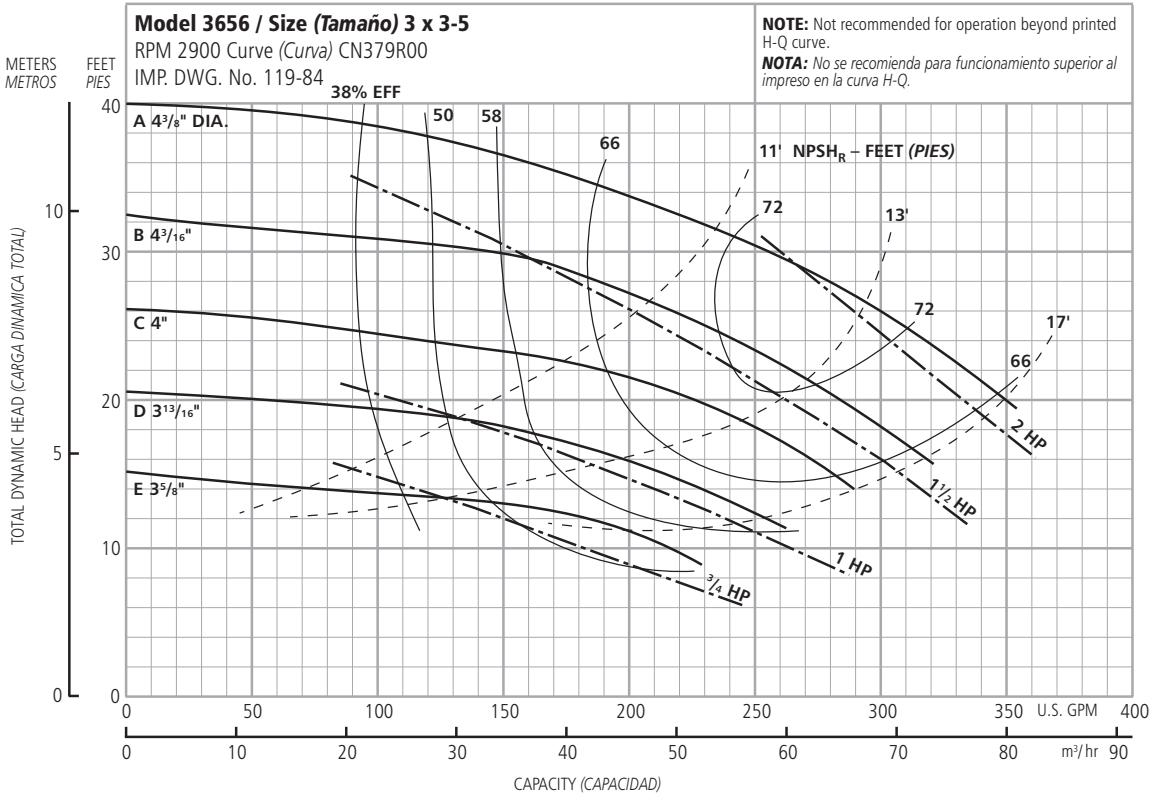

Optional Impeller Impulsor optativo	
Ordering Code Código de pedido	Dia. Diá.
A	4 ³ / ₈ "
B	4 ⁷ / ₁₆ "
C	4"
D	3 ¹³ / ₁₆ "
E	3 ⁵ / ₈ "

NOTE: Pump will pass a sphere to 5/32" diameter.
NOTA: La bomba dejará pasar una esfera de hasta 5/32 de pulgada de diámetro.

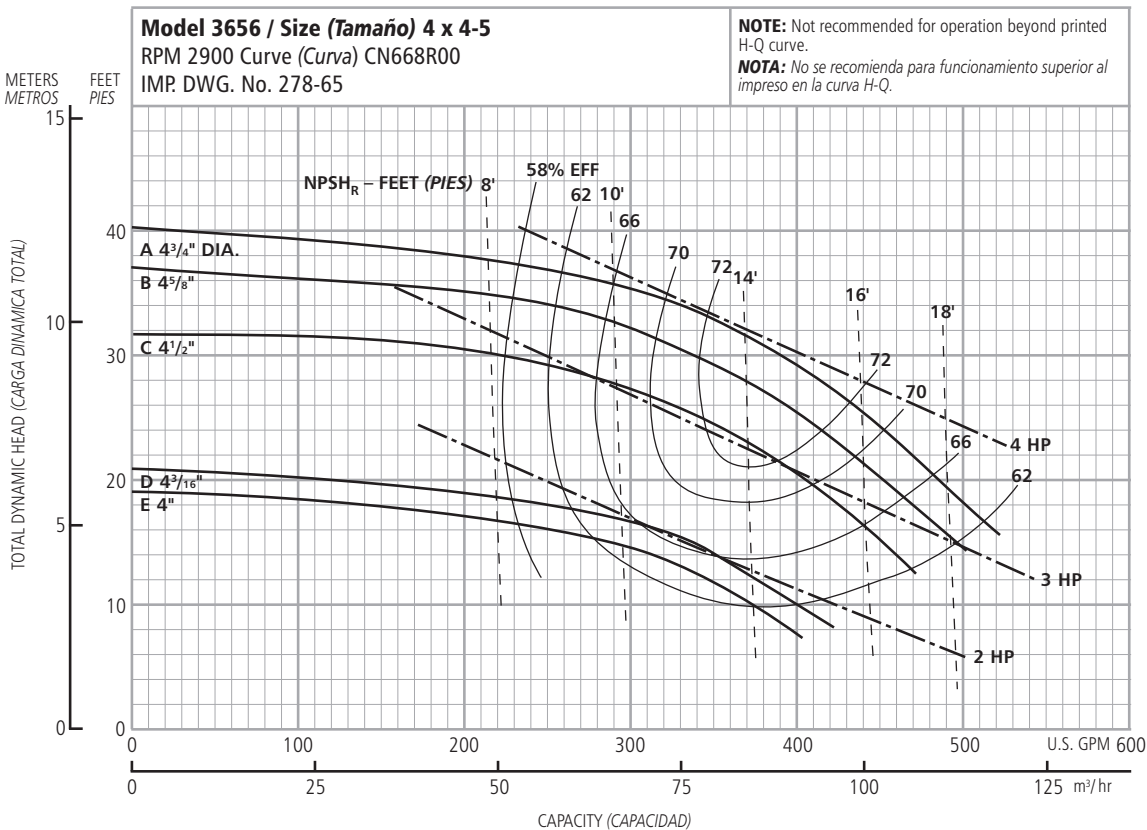

Optional Impeller Impulsor optativo	
Ordering Code Código de pedido	Dia. Diá.
A	4 ³ / ₄ "
B	4 ⁵ / ₈ "
C	4 ¹ / ₂ "
D	4 ³ / ₁₆ "
E	4"

NOTE: Pump will pass a sphere to 3/32" diameter.
NOTA: La bomba dejará pasar una esfera de hasta 3/32 de pulgada de diámetro.

PERFORMANCE CURVES, CURVAS DE FUNCIONAMIENTO

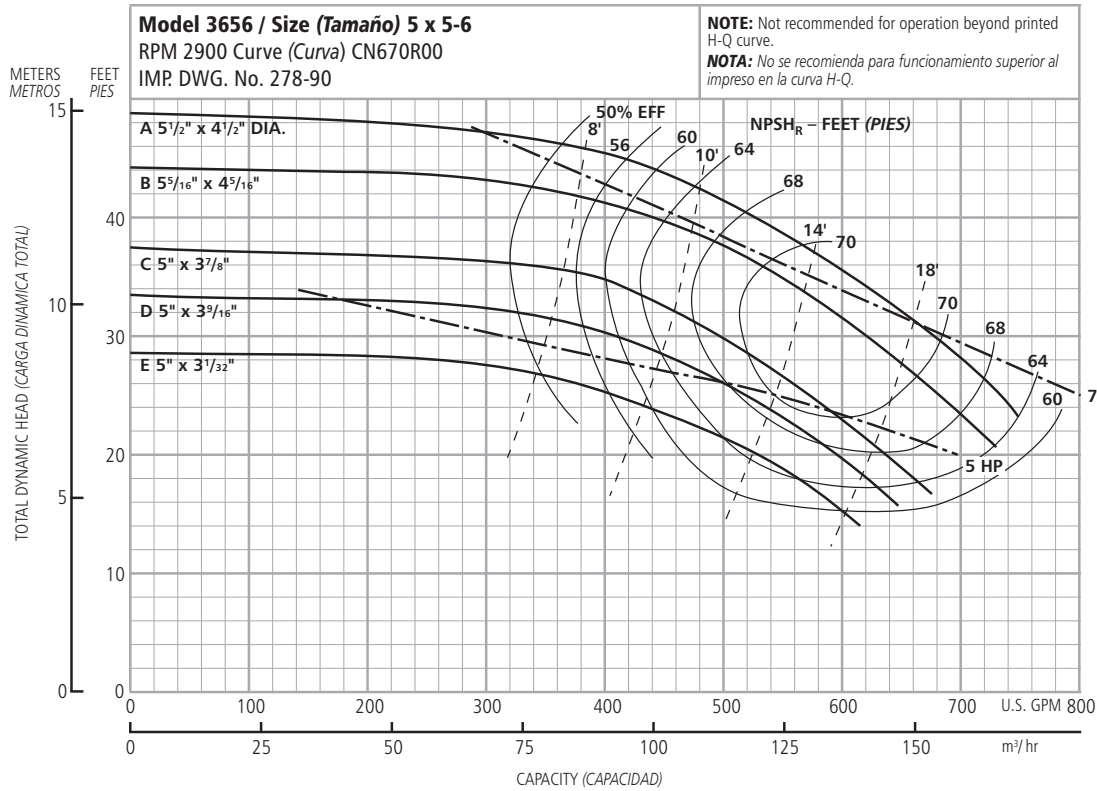

Optional Impeller Impulsor optativo	
Ordering Code Código de pedido	Dia. Día.
A	5 1/2 x 4 1/2
B	5 5/16 x 4 5/16
C	5 x 3 7/8
D	5 x 3 9/16
E	5 x 3 1/2

NOTE: Pump will pass a sphere to 5/32" diameter.
NOTA: La bomba dejará pasar una esfera de hasta 5/32 de pulgada de diámetro.

MATERIALS OF CONSTRUCTION, MATERIALES DE CONSTRUCCIÓN

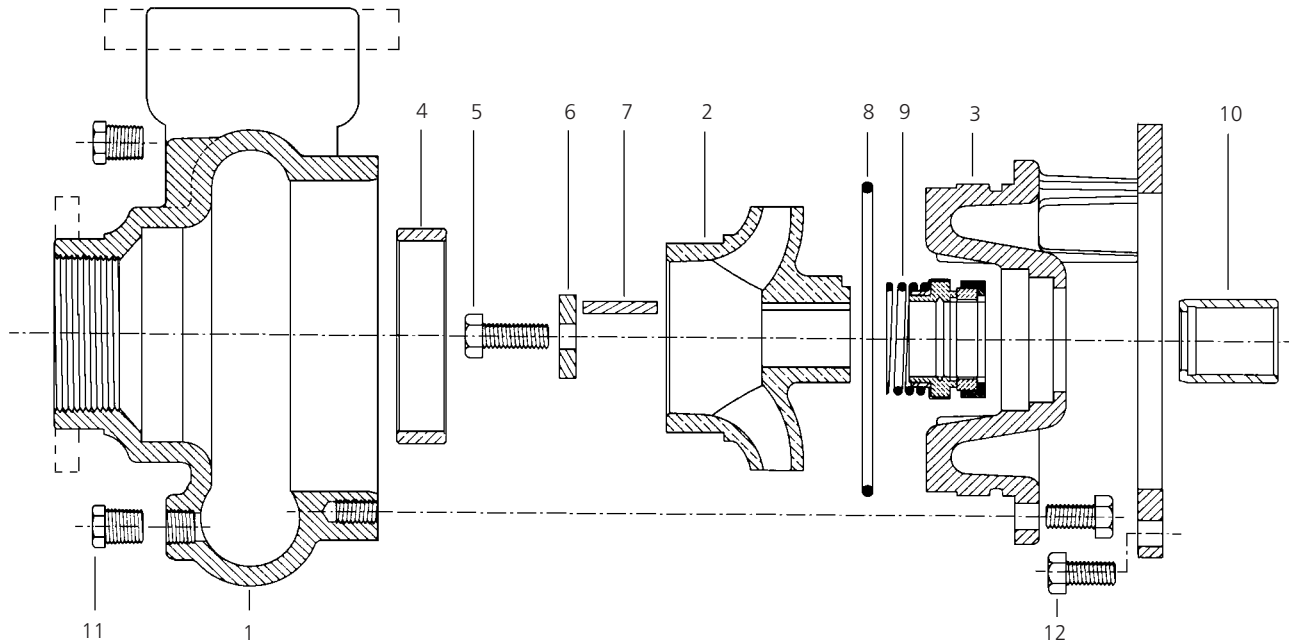

Item No., Parte No.	Description, Descripción	Material, Materiales	
1	Casing, <i>Carcasa</i>	Cast iron, <i>Hierro fundido</i>	
2	Impeller, <i>Impulsor</i>	Cast iron/Sil-brass, <i>Hierro fundido/Bronce</i>	
3	Motor adapter, <i>Adaptador del motor</i>	Cast iron, <i>Hierro fundido</i>	
4	Casing wearing ring, <i>Anillo de desgaste de la carcasa</i>	Cast iron/Sil-brass, <i>Hierro fundido/Bronce</i>	
5	Impeller bolt, <i>Tornillo del impulsor</i>		
6	Impeller washer, <i>Arandela del impulsor</i>	304 SS,	
7	Square key way, <i>Chavetero cuadrado</i>	304 Acero inoxidable	
8	O-ring, <i>Anillo 'O'</i>	BUNA/EPR/Viton	
9	Seal Code, Código del Sello	Rotary, Stationary, Rotativo Estacionario Elastomers, Elastómeros Metal Parts, Partes Metálicas Part No., Pieza Número	
	0	Carbon Ceramic BUNA	Type 316 SS, 10K13
	1	Carbon Sil-Carb. EPR	Tipo 316 SS, 10K19
	3	Carbon Sil-Carb. Viton	Tipo 316 SS, 10K27
	5	Sil-Carb. Sil-Carb. Viton	10K64
10	Shaft sleeve, <i>Camisa del eje</i>	304 SS, <i>304 Acero inoxidable</i>	
11	1/4" pipe plug, <i>Tapón macho roscado de 1/4"</i>	Steel, Zinc plated <i>Acero, cinc plateado</i>	
12	Hex head screw, <i>Tornillo de cabeza hexagonal</i>	Steel, zinc plated <i>Acero, cinc plateado</i>	

Material, <i>Materiales</i>	Engineering Standard, <i>Estándar Aprobado</i>
Cast iron, <i>Hierro fundido</i>	ASTM A48CL30
Silicon brass (lead free), <i>Bronce del silicio (sin plomo)</i>	ASTM B584 C87500 (modified, <i>modificado</i>)

3656LH DIMENSIONS AND WEIGHTS, 3656LH DIMENSIONES Y PESOS

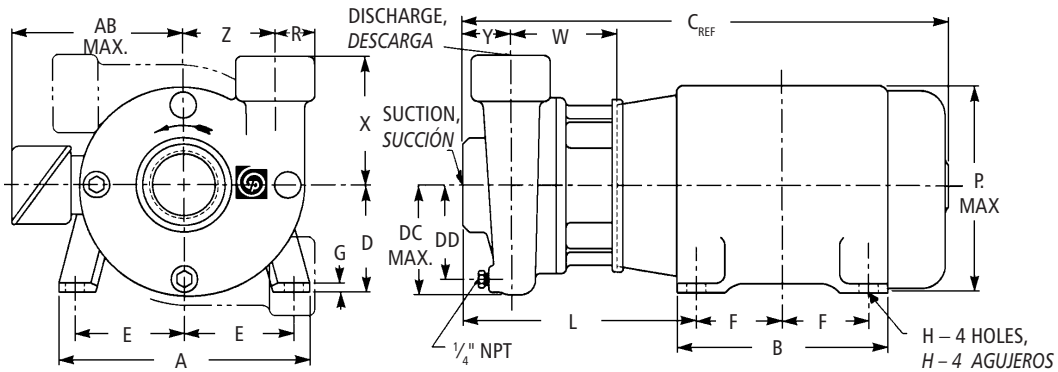

Close Coupled Dimensions Determined by Pump, Dimensiones del Acople Cerrado Determinadas por la Bomba

Pump Size, Tamaño de la Bomba	Suction, Succión	Discharge, Descarga	DC Max., DC Máx.	DD	R	W	X	Y	Z	Wt. (lbs.), Peso (libras)	Dimension "L" Motor Frame Size, Tamaño del bastidor del motor de dimensión "L"	
											140	180
2 x 2 - 5	2	2	3 ¹ / ₁₆	2 ¹ / ₁₆	1 ⁵ / ₈	4 ¹ / ₈	5	3	3 ³ / ₁₆	26	10	10 ⁵ / ₈
2 ¹ / ₂ x 2 ¹ / ₂ - 5	2 ¹ / ₂	2 ¹ / ₂	4 ³ / ₄	3 ³ / ₄	3 ³ / ₈	4 ¹ / ₄	6		3 ¹ / ₂	31	10 ¹ / ₈	10 ³ / ₄
3 x 3 - 5	3	3	5 ⁵ / ₁₆	4 ⁵ / ₁₆	2 ³ / ₁₆	4 ¹ / ₂		6	3 ¹ / ₂	3 ⁷ / ₈	37	10 ¹ / ₈

NOTES:

1. Pumps will be shipped with top vertical discharge as standard. For other orientations, remove casing bolts, rotate to desired position, replace and tighten bolts to 37 lb. - ft.

2. Dimensions are in inches.

3. Motor dimensions may vary with motor manufacturer.

4. Not to be used for construction purposes.

Dimensions Determined by Motor, Dimensiones Determinadas por el Motor

Motor Frame, Armazón del Motor	A	AB Max., AB Máx.	B	C _{REF}	D	E	F	G	H	P. Max., P. Máx.
143JM	6 ¹ / ₂	5 ¹ / ₄	6	11 ¹ / ₄	3 ¹ / ₂	2 ³ / ₄	2	1 ¹ / ₈	1 ¹ / ₃₂	6 ⁵ / ₈
145JM							2 ¹ / ₂			
182JM	8 ¹ / ₂	5 ⁷ / ₈	6 ¹ / ₂	15	4 ¹ / ₂	3 ³ / ₄	2 ¹ / ₄	3 ¹ / ₁₆	1 ³ / ₃₂	7 ¹ / ₈
184JM							2 ³ / ₄			
213TCZ	10 ¹ / ₂	7 ³ / ₈	8	18 ¹ / ₂	5 ¹ / ₄	4 ¹ / ₄	2 ³ / ₄	1 ¹ / ₄	1 ³ / ₃₂	9 ⁵ / ₈

NOTAS:

1. Las bombas se transportarán con la descarga vertical superior como estándar. Para otras orientaciones, retirar los tornillos de la carcasa, rotar a la posición deseada, reemplazar y apretar los tornillos 37 libras - pies.

2. Las dimensiones son en pulgadas.

3. Las dimensiones del motor pueden que varíen con los fabricantes.

4. No debe usarse para propósitos de construcción.

Horsepowers, Fuerzas

Motor Frame, Armazón del Motor	HP @ 3500 RPM				HP @ 1750 RPM				Wt. (lbs.), Peso (libras)
	1 Phase, Monofásicos		3 Phase, Trifásicos		1 Phase, Monofásicos		3 Phase, Trifásicos		
	ODP	TEFC	ODP	TEFC	ODP	TEFC	ODP	TEFC	
143JM	3/4, 1, 1 1/2	3/4, 1, 1 1/2	3/4, 1, 1 1/2	3/4, 1, 1 1/2	1/2, 3/4	1/2, 3/4	1/2, 3/4, 1	1/2, 3/4, 1	41
145JM	2	2	2,3	2,3	1	1	1 1/2, 2	1 1/2, 2	57
182JM	3	3	5	3	3	-	3	3	77
184JM	5	3, 5	7 1/2	5, 7 1/2	3	-	5	5	97
213TCZ	-	-	10	10	-	-	-	-	133

3656LH DIMENSIONS AND WEIGHTS, 3656LH DIMENSIONES Y PESOS

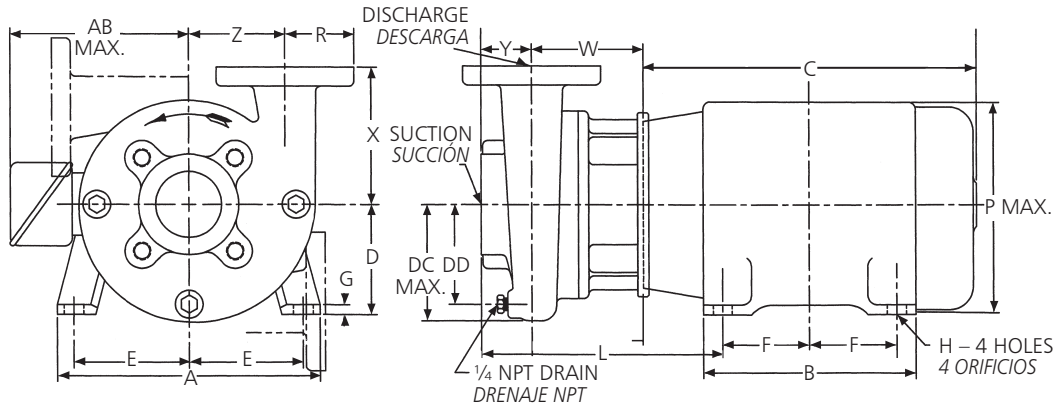

Close Coupled Dimensions Determined by Pump, Dimensiones del Acople Cerrado Determinadas por la Bomba

Pump Size, Tamaño de la Bomba	Suction*, Succión	Discharge*, Descarga	DC Max., DC Max.	DD	R	W	X	Y	Z	Wt. (lbs.), Peso (libras)	Dimension "L" Motor Frame Size, Tamano del bastidor del motor de dimension "L"		
											140	180	210
4 x 4 – 5	4	6 1/2	5 1/4	4 1/2	4 1/4	7	4	4 1/2	110	11 3/8	12	12 7/8	
5 x 5 – 6	5	8	6 1/4	5	8	8	5 1/2	125					

* ANSI Class 125 flanges, Bidas ANSI Clase 125

Dimensions Determined by Motor, Dimensiones Determinadas por el Motor

Motor Frame, Armazn del Motor	A	AB Max., AB Max.	B	C	D	E	F	G	H	P. Max., P. Max.
143JM	6 1/2	5 1/4	6	11 1/4	3 1/2	2 3/4	2	1/8	1 1/32	6 5/8
145JM							2 1/2			
182JM	8 1/2	5 5/8	6 1/2	15	4 1/2	3 3/4	2 1/4	3/16	1 3/32	7 7/8
184JM							2 3/4			
213JM	10 1/2	7 3/8	8	18 1/2	5 1/4	4 1/4	2 3/4	1/4	1 3/32	9 5/8
213TCZ				20			3 1/2			
215JM										

Horsepowers, Fuerzas

Motor Frame, Armazn del Motor	HP @ 3500 RPM				HP @ 1750 RPM				Wt. (lbs.), Peso (libras)
	1 Phase, Monofsicos		3 Phase, Trifsicos		1 Phase, Monofsicos		3 Phase, Trifsicos		
	ODP	TEFC	ODP	TEFC	ODP	TEFC	ODP	TEFC	
143JM	3/4, 1, 1 1/2	3/4, 1, 1 1/2	3/4, 1, 1 1/2	3/4, 1, 1 1/2	1/2, 3/4	1/2, 3/4	1/2, 3/4, 1	1/2, 3/4, 1	41
145JM	2	2	2,3	2,3	1	1	1 1/2, 2	1 1/2, 2	57
182JM	3	3	5	3	3	–	3	3	77
184JM	5	3, 5	7 1/2	5, 7 1/2	3	–	5	5	97
213JM	7 1/2	–	7 1/2, 10	7 1/2	–	–	–	–	133
213TCZ	–	7 1/2	–	7 1/2	–	–	–	–	133
215JM	10	7 1/2, 10	7 1/2, 10, 15	7 1/2, 10, 15	–	–	–	–	154

NOTES:

- Pumps will be shipped with top vertical discharge as standard. For other orientations, remove casing bolts, rotate to desired position, replace and tighten bolts to 37 lb. – ft.
- Dimensions are in inches.
- Motor dimensions may vary with motor manufacturer.
- Not to be used for construction purposes.

NOTAS:

- Las bombas se transportarn con la descarga vertical superior como estndar. Para otras orientaciones, retirar los tornillos de la carcasa, rotar a la posicin deseada, reemplazar y apretar los tornillos a 37 libras – pies.
- Las dimensiones son en pulgadas.
- Las dimensiones del motor pueden que varen con los fabricantes.
- No debe usarse para propositos de construccin.

3756LH DIMENSIONS AND WEIGHTS, 3756LH DIMENSIONES Y PESOS

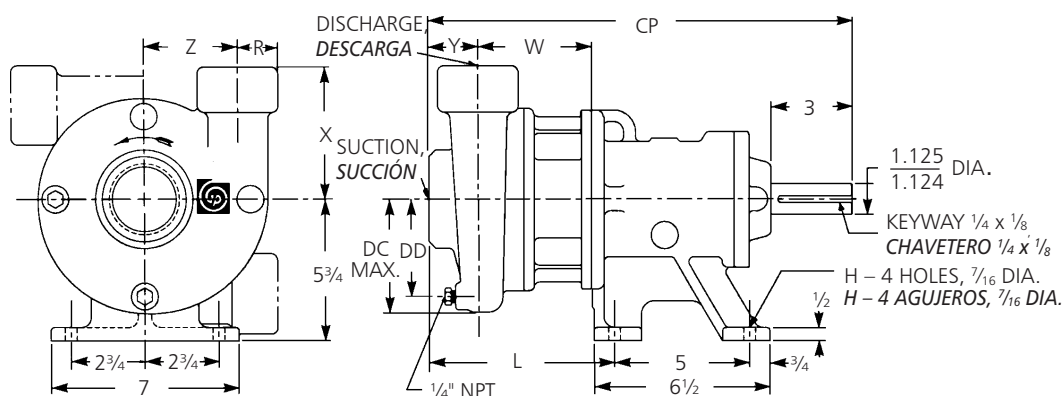

Frame Mounted Dimensions Determined by Pump, Dimensiones del Armazón Montado Determinadas por la Bomba

Pump Size, Tamaño de la Bomba	Suction*, Succión	Discharge*, Descarga	CP	DC Max., DC Máx.	DD	L	R	W	X	Y	Z	Wt. (lbs.), Peso (libras)	HL Motor Frame, Armazón del Motor HL
2 x 2 - 5	2	2	16 3/4	3 15/16	2 15/16	9 1/2	1 3/8	4 1/8	5	3	3 5/16	26	9 1/2
2 1/2 x 2 1/2 - 5	2 1/2	2 1/2	17 3/8	4 3/4	3 3/4	9 5/8	3 3/8	4 1/4	6	3 1/2	3 1/2	31	9 5/8
3 x 3 - 5	3	3	17 7/8	5 1/16	4 1/16	10 3/8	2 3/16	4 1/2	3 1/2	3 3/8	3 3/8	37	10 3/8

* NPT connections, Conexiones NPT

Dimensions Determined by Bedplate, Dimensiones Determinadas por la Fundación

Motor Frame, Armazón del Motor	HA	HB	HD	HE	HF	HG	HL	HP	Wt. (lbs.), Peso (libras)	Motor Shim, Deflector del Motor	Bearing Frame Shim, Armazón de Balineras
143T	10	28	8	3 3/4	24	2 3/4	10 3/8	3/4	47	1 3/4	-
145T											
182T											
184T											

Horsepowers, Fuerzas

Motor Frame, Armazón del Motor	HP @ 3500 RPM				HP @ 1750 RPM				AB Max., AB Máx.	C Max., C Máx.	P Max., P Máx.	Wt. (lbs.), Peso (libras)
	1 PH, Monofásicos		3 PH, Trifásicos		1 PH, Monofásicos		3 PH, Trifásicos					
	ODP	TEFC	ODP	TEFC	ODP	TEFC	ODP	TEFC				
143T	3/4, 1, 1 1/2	3/4, 1, 1 1/2	3/4, 1, 1 1/2	3/4, 1, 1 1/2	1/2, 3/4	1/2, 3/4	1/2, 3/4, 1	1/2, 3/4, 1	5 1/4	13 3/8	6 7/8	45
145T	2	2	2, 3	2, 3	1	1	-	-	5 1/4	14 1/4	6 7/8	53
182T	3	-	5	3	-	-	-	-	5 7/8	16 5/8	7 7/8	74
184T	5	3	-	5	-	-	-	-	5 7/8	18 1/8	7 7/8	95

NOTES:

- Pumps will be shipped with top vertical discharge as standard. For other orientations, remove casing bolts, rotate to desired position, replace and tighten bolts to 37 lb. - ft.
- Dimensions are in inches.
- Motor dimensions may vary with motor manufacturer.
- Not to be used for construction purposes.

NOTAS:

- Las bombas se transportarán con la descarga vertical superior como estándar. Para otras orientaciones, retirar los tornillos de la carcasa, rotar a la posición deseada, reemplazar y apretar los tornillos a 37 libras - pies.
- Las dimensiones son en pulgadas.
- Las dimensiones del motor pueden que varien con los fabricantes.
- No debe usarse para propósitos de construcción.

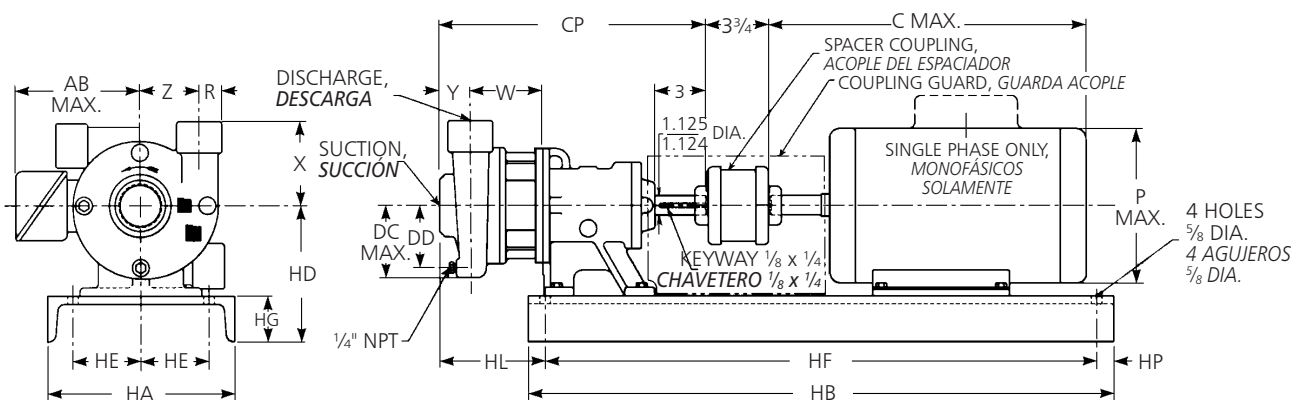

3756LH DIMENSIONS AND WEIGHTS, 3756LH DIMENSIONES Y PESOS

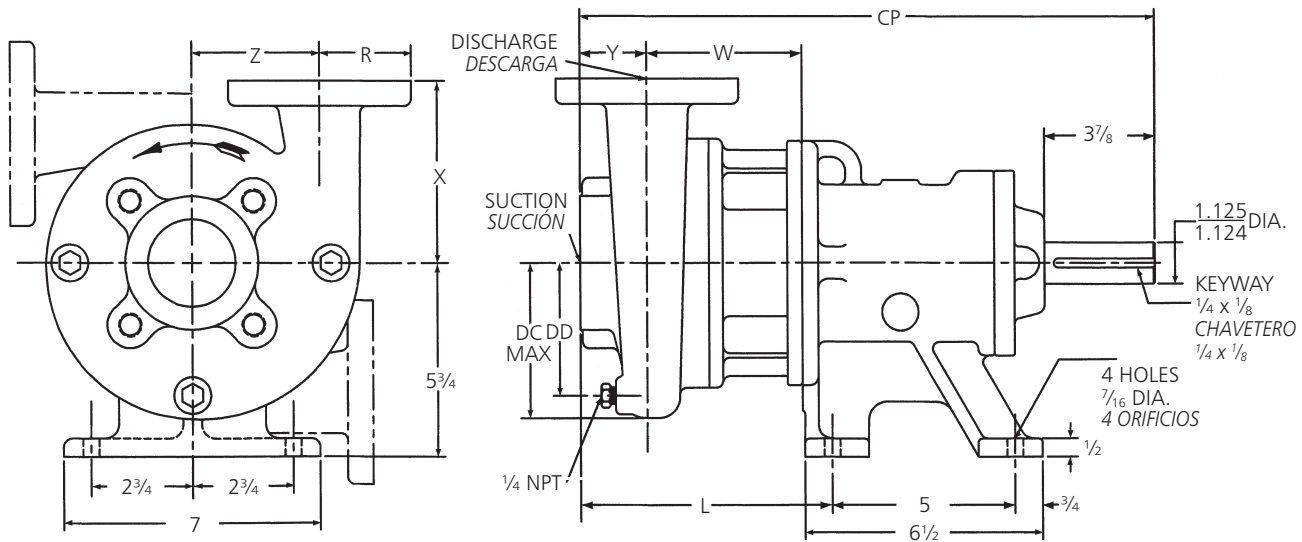

Frame Mounted Dimensions Determined by Pump, Dimensiones del Armazón Montado Determinadas por la Bomba

Pump Size, Tamaño de la Bomba	Suction*, Succión	Discharge*, Descarga	CP	DC Max., DC Máx.	DD	L	R	W	X	Y	Z	HL Motor Frame Armazón del Motor HL		Wt. (lbs.), Peso (libras)
												140-180	210	
4 x 4 - 5	4		17 ⁷ / ₈	6 ¹ / ₂	5 ¹ / ₄	8 ³ / ₄	4 ¹ / ₂	4 ¹ / ₄	7	4	4 ¹ / ₂	10 ¹ / ₄	8 ³ / ₄	142
5 x 5 - 6	5			8	6 ¹ / ₄	9 ² / ₃₂	5	4 ¹ / ₄	8		5 ¹ / ₂	11 ¹ / ₃₂	9 ² / ₃₂	157

* ANSI Class 125 Flanges, Bridas ANSI Clase 125

Dimensions Determined by Bedplate, Dimensiones Determinadas por la Fundación

Motor Frame, Armazón del Motor	HA	HB	HD	HE	HF	HG	HP	Wt. (lbs.), Peso (libras)	Motor Shim, Deflector del Motor	Bearing Frame Shim, Armazón de Balineras
143T	10	28	8	3 ³ / ₄	24	2 ³ / ₄	3 ³ / ₄	47	1 ³ / ₄	-
145T										
182T										
184T										
213T/215T	12	31	8 ¹ / ₄	4 ¹ / ₄	29	3	1	65	-	-

Horsepowers, Fuerzas

Motor Frame, Armazón del Motor	HP @ 3500 RPM				HP @ 1750 RPM				AB Max., AB Máx.	C Max., C Máx.	P Max., P Máx.	Wt. (lbs.), Peso (libras)
	1 PH, Monofásicos		3 PH, Trifásicos		1 PH, Monofásicos		3 PH, Trifásicos					
	ODP	TEFC	ODP	TEFC	ODP	TEFC	ODP	TEFC				
143T	3/4, 1, 1 1/2	3/4, 1, 1 1/2	3/4, 1, 1 1/2	3/4, 1, 1 1/2	1/2, 3/4	1/2, 3/4	1/2, 3/4, 1	1/2, 3/4, 1	5 1/4	14	6 7/8	45
145T	2	2	2,3	2,3	1	1	2	2	5 1/4	14 1/4	6 7/8	53
182T	3	3	5	3	2	2,3	3	3	6 3/8	16 5/8	7 7/8	74
184T	5	3, 5	7 1/2	5	3	-	5	5	6 3/8	18 1/8	7 7/8	95
213T	7 1/2	-	10	7 1/2	5	-	7 1/2	7 1/2	8 1/2	20	9 5/8	116
215T	10	-	15	10, 15	-	-	10	10	8 1/2	20	9 5/8	136

NOTES:

- Pumps will be shipped with top vertical discharge as standard. For other orientations, remove casing bolts, rotate to desired position, replace and tighten bolts to 37 lb. - ft.
- Dimensions are in inches.
- Motor dimensions may vary with motor manufacturer.
- Not to be used for construction purposes.

NOTAS:

- Las bombas se transportarán con la descarga vertical superior como estándar. Para otras orientaciones, retirar los tornillos de la carcasa, rotar a la posición deseada, reemplazar y apretar los tornillos a 37 libras - pies.
- Las dimensiones son en pulgadas.
- Las dimensiones del motor pueden que varíen con los fabricantes.
- No debe usarse para propósitos de construcción.

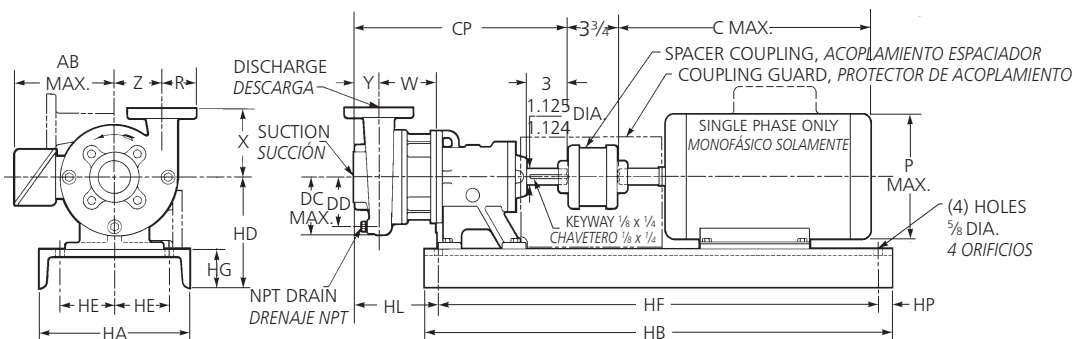

SPECIFICATIONS, *ESPECIFICACIONES*

Capacities to:

900 GPM (204 m³/hr) at 3500 RPM

Heads to:

65 feet THD (19.8 m) at 3500 RPM

Working pressure to:

175 PSIG (12 bars)

Maximum suction pressure to:

100 PSIG (9 bars)

Maximum temperature to:

212°F (100°C) with standard seal or

250°F (121°C) with optional seal

Motor:

NEMA standard JM frame for 3656LH or T-frame for 3756LH. Open dripproof, totally enclosed fan cooled and explosion proof enclosures available.

Single phase (115/230 V) and Three phase (208 – 230/460 V) versions are available. Horsepowers are 1/2 at 1750 RPM and 3/4 – 5 HP at 3500 RPM.

Capacidades:

900 GPM (204 m³/hr) a 3500 RPM

Cargas:

65 pies THD (19.8 m) a 3500 RPM

Presión de trabajo a:

175 PSIG (12 baras)

Presión máxima de succión a:

100 PSIG (9 baras)

Temperatura máxima:

212°F (100°C) con sello estándar o

250°F (121°C) con sello opcional

Motor:

Armazón JM estándar NEMA para 3656LH o armazón T para 3756LH. A prueba de goteo, ventilador totalmente encerrado y recintos a prueba de explosión disponibles.

Las versiones para Monofásicos (115/230 V) y Trifásicos (208-230/460 V) están disponibles. Las fuerzas son 1/2 HP a 1750 RPM y 3/4 – 5HP a 3500 RPM.

TYPICAL APPLICATIONS, *APLICACIONES TÍPICAS*

- Evaporative condensers
- Industrial fluid coolers
- Refrigeration and air conditioning systems
- Water circulation
- Liquid transfer
- Irrigation
- Condensadores de goteo
- Enfriadores industriales de líquidos
- Sistemas de refrigeración y aire acondicionado
- Circulación de agua
- Transferencia de líquidos
- Irrigación

NOTES, NOTAS

NOTES, NOTAS

Xylem |'zīləm|

- 1) The tissue in plants that brings water upward from the roots;
- 2) a leading global water technology company.

We're 12,000 people unified in a common purpose: creating innovative solutions to meet our world's water needs. Developing new technologies that will improve the way water is used, conserved, and re-used in the future is central to our work. We move, treat, analyze, and return water to the environment, and we help people use water efficiently, in their homes, buildings, factories and farms. In more than 150 countries, we have strong, long-standing relationships with customers who know us for our powerful combination of leading product brands and applications expertise, backed by a legacy of innovation.

For more information on how Xylem can help you, go to www.xylem.com

Xylem |'zīləm|

- 1) El tejido en las plantas que hace que el agua suba desde las raíces;
- 2) una compañía líder global en tecnología en agua.

Somos 12.000 personas unificadas por un propósito en común: crear soluciones innovadoras para satisfacer las necesidades de agua de nuestro mundo. Desarrollar nuevas tecnologías que mejorarán la manera en que se usa, se conserva y se reutiliza el agua en el futuro es un aspecto crucial de nuestra labor. Transportamos, tratamos, analizamos y retornamos el agua al medio ambiente, y ayudamos a las personas a usar el agua de manera eficiente, en sus casas, edificios, fábricas y campos. En más de 150 países, tenemos relaciones sólidas desde hace mucho tiempo con clientes que nos conocen por nuestra potente combinación de marcas de producto líderes y conocimientos de aplicación, con el respaldo de nuestro legado de innovación.

Para obtener más información, visite [xylem.com](http://www.xylem.com).



Xylem, Inc.
2881 East Bayard Street Ext., Suite A
Seneca Falls, NY 13148
Phone: (800) 453-6777
Fax: (888) 322-5877
www.xylem.com/brands/gouldswatertechnology

Goulds is a registered trademark of Goulds Pumps, Inc. and is used under license.
© 2012 Xylem Inc. B3656LH March (Marzo) 2012