



# e-SV™ Series

STAINLESS STEEL VERTICAL MULTISTAGE PUMPS

DESIGNED FOR EFFICIENCY. BUILT FOR PERFORMANCE.

# Where efficiency meets performance

The e-SV fabricated vertical multistage pump is an energy saving, non-priming pump coupled to a standard premium-efficient motor. It's built to withstand a variety of mechanically aggressive and high temperature liquids, and is designed to extend uptime and help reduce lifecycle costs in a wide range of demanding applications.

The e-SV range of pumps features 11 models, and each can be specially configured for a wide range of environments. What's more, when an e-SV is paired with a HYDROVAR® or AQUAVAR® IPC variable speed drive, it provides energy saving increases up to 70% vs. fixed speed, while reducing installation time.

Also available in pre-programmed, pre-assembled packages, the e-SVE Smart Pump and Packaged HYDROVAR are complete systems, delivering market-leading efficiency and performance right out of the box.



**POWER GENERATION**

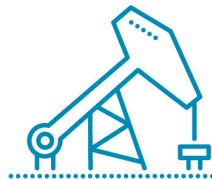

**OIL & GAS**



**GENERAL MANUFACTURING**



**POOL & LEISURE**



**MINING**



**WATER UTILITIES**

## extra efficient

The e-SV's hydraulics, combined with a high-efficiency motor (EISA compliant) deliver maximum efficiency.

## energy saving

Pumps are among the largest users of industrial energy. Do your part to reduce CO<sub>2</sub> emissions and your impact on the environment -- and improve your bottom line - by taking advantage of the e-SV's lower energy requirement. Use a e-SV pump along with a variable speed drive such as Xylem HYDROVAR, and save even more energy and

## easy to maintain

The e-SV's design allows removal of the mechanical seal without having to remove the motor, reducing repair time by up to 50%. A standard mechanical seal, wearing components, service tools and standard NEMA motors enable faster and easier maintenance and servicing.

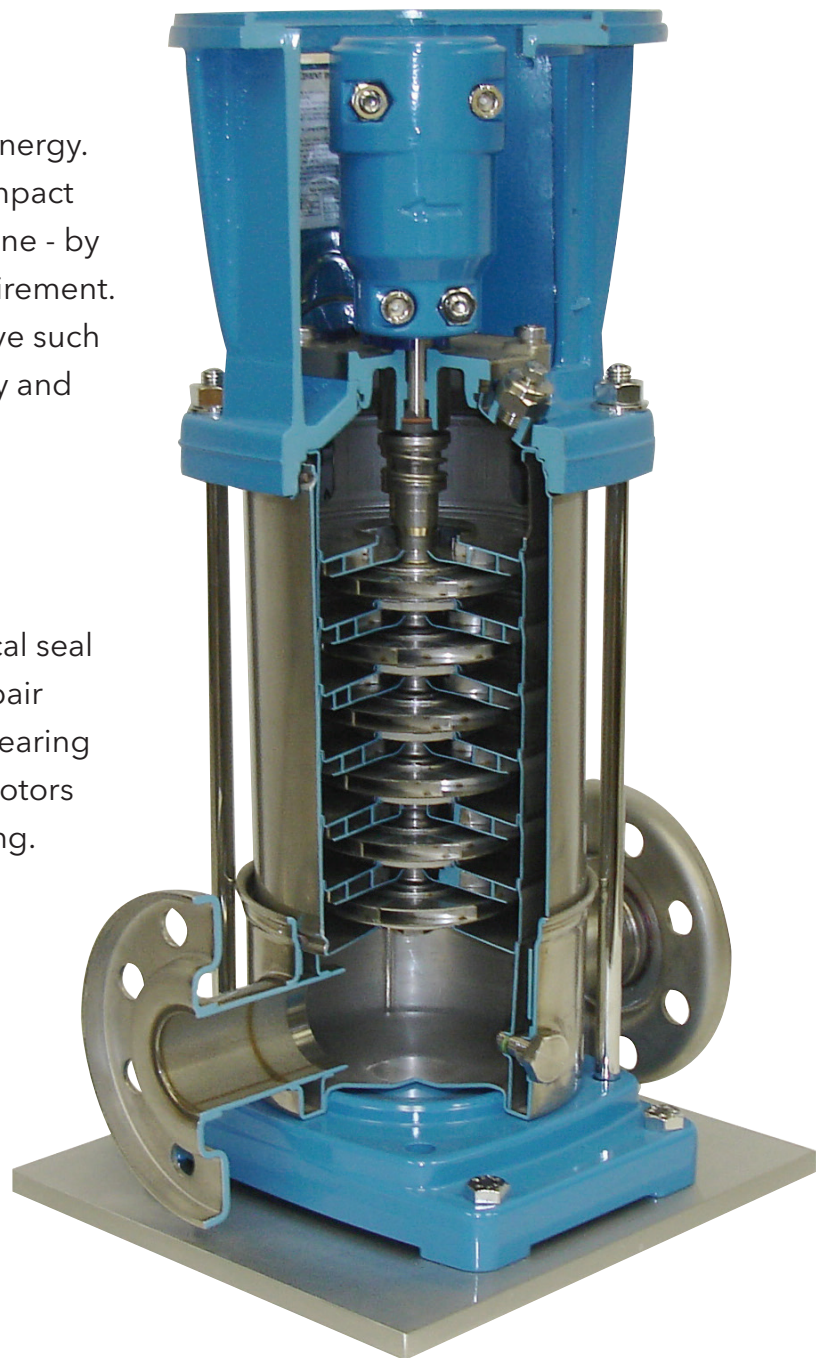

# Broad range of solutions delivering market-leading efficiency and performance



e-SVE  
Smart Pump



e-SV



AQUAVAR IPC



HYDROVAR



Packaged HYDROVAR

# The e-SV pump

The e-SV pump, the product at the heart of the e-SV Series, is one of the highest efficiency multistage pumps on the market today. This fabricated vertical multistage pump is also easy to install and economical to maintain. When it comes to efficiency, the e-SV delivers.



## Benefits

- The expanded hydraulic coverage of an e-SV pump combined with a premium-efficient motor delivers maximum performance.
- The extended e-SV portfolio allows you to select a pump aligned with your application's optimum duty point.
- A variable speed drive such as HYDROVAR or AQUAVAR IPC increases an e-SV's energy savings up to 70% vs. fixed speed while reducing installation time.
- Standard models offer low NPSH, with even lower NPSH models available.
- e-SV pumps are available in horizontal and vertical configurations.
- You can choose the flange orientation or type to meet your piping needs.
- The mechanical seal can be replaced quickly and easily, reducing repair time by up to 50%.
- The pump can be easily repaired right in the piping.
- The O-ring seat is designed to allow easy outer sleeve disassembly.
- The standard mechanical seal, wearing components, service tools and NEMA motors enable faster, easier maintenance and servicing.
- To simplify maintenance, a repair stack assembly is available for quick and efficient installation and repair.

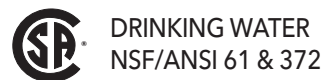

## e-SV Specifications

- **Delivery:** up to 725 GPM
- **Head:** up to 1200 feet
- **Maximum operating pressure:**
  - 1-22SV with oval flanges: 230 psi (16 bar)
  - 1-22SV with round flanges or Victaulic: 360 or 575 psi (25 or 40 bar)
  - 33 & 46SV: 360 or 580 psi (25 or 40 bar)\*
  - 66 & 92SV: 360 or 580 psi (25 or 40 bar)\*
  - 125SV: 360 or 580 psi (25 or 40 bar)
- **Temperature of pumped liquid:** -20°F to 250°F (-30°C to 120°C) standard version
- **Direction of rotation:** clockwise looking at the pump from the top down (marked with an arrow on the adapter and on the coupling).

\* Based on pump staging

# Built to perform

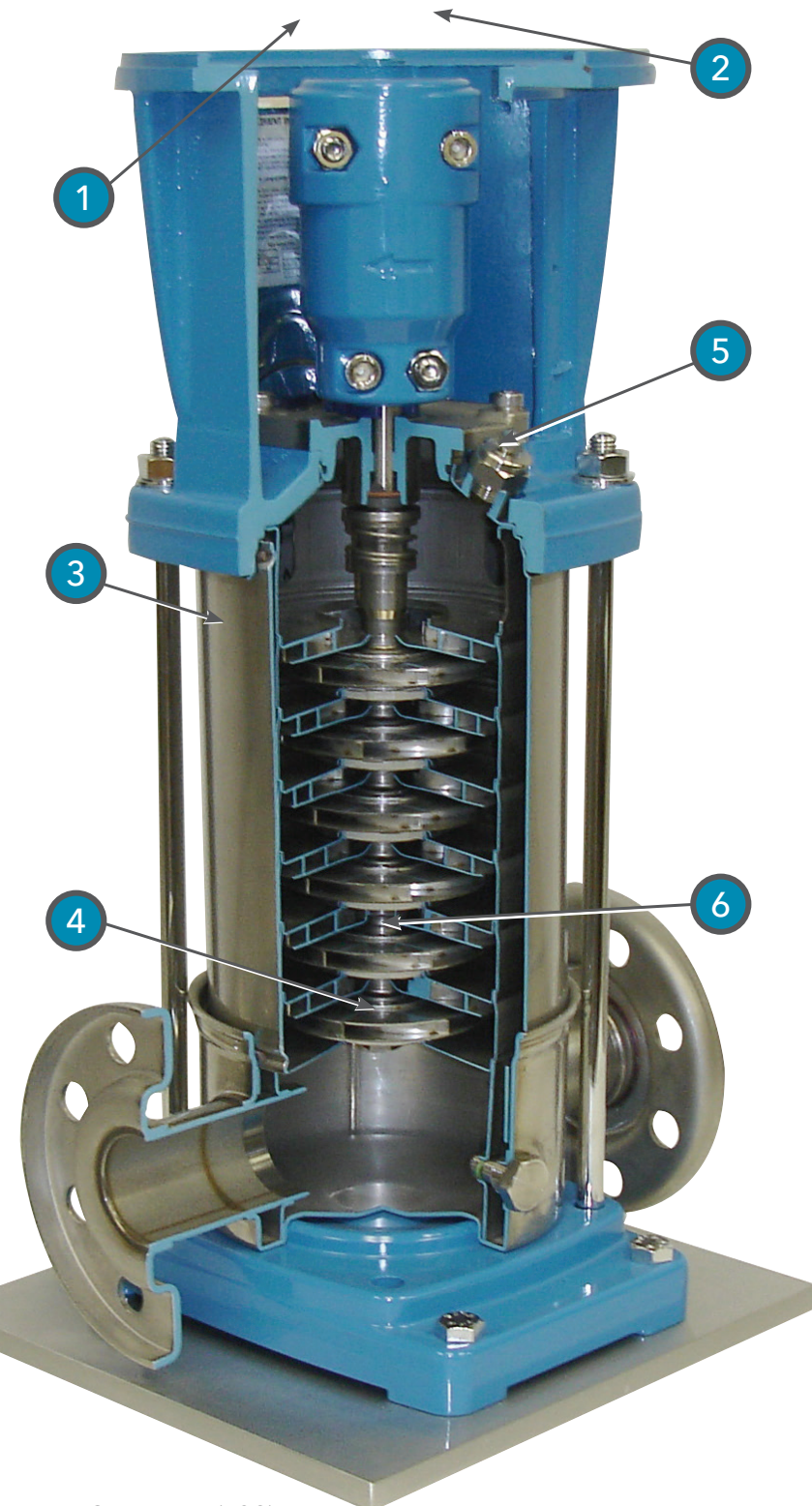

1. **Motor (Not shown)** - Standard e-SV high efficiency motors range from 0.5 HP to 75HP. The e-SVE features the Xylem Smart Motor, an "ultra premium" (IE5) motor. All motors are aligned with 2016 DOE requirements.
2. **Motor enclosure (Not shown)** - The enclosure is washdown and explosion proof, and premium efficient enclosures are available. They are compatible with a wide variety of industrial and commercial building applications.
3. **Casing** - The stainless steel casing provides durability and long life. Single and double wall options are available. They are compatible with high pressure applications such as pressure boosting.
4. **Wear ring** - The floating, self-aligning, glass filled, high temperature polymer diffuser wear ring withstands corrosive, aggressive and high temperature liquids. It protects against abrasion and debris for reliable, long lasting performance.
5. **Plugs** - Top fill plugs with air vents allow for easy installation and removal of trapped air in the seal housing. These are available on all models.
6. **Bearings** - The tungsten carbide bushing improves longevity, reliability and the ability to withstand heavy duty applications such as boiler feeding.

Some parts (1&2) are aligned with motor which is not in cut-away



Top fill plugs with air vents available for all models

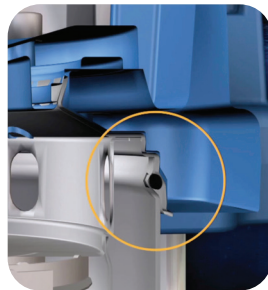
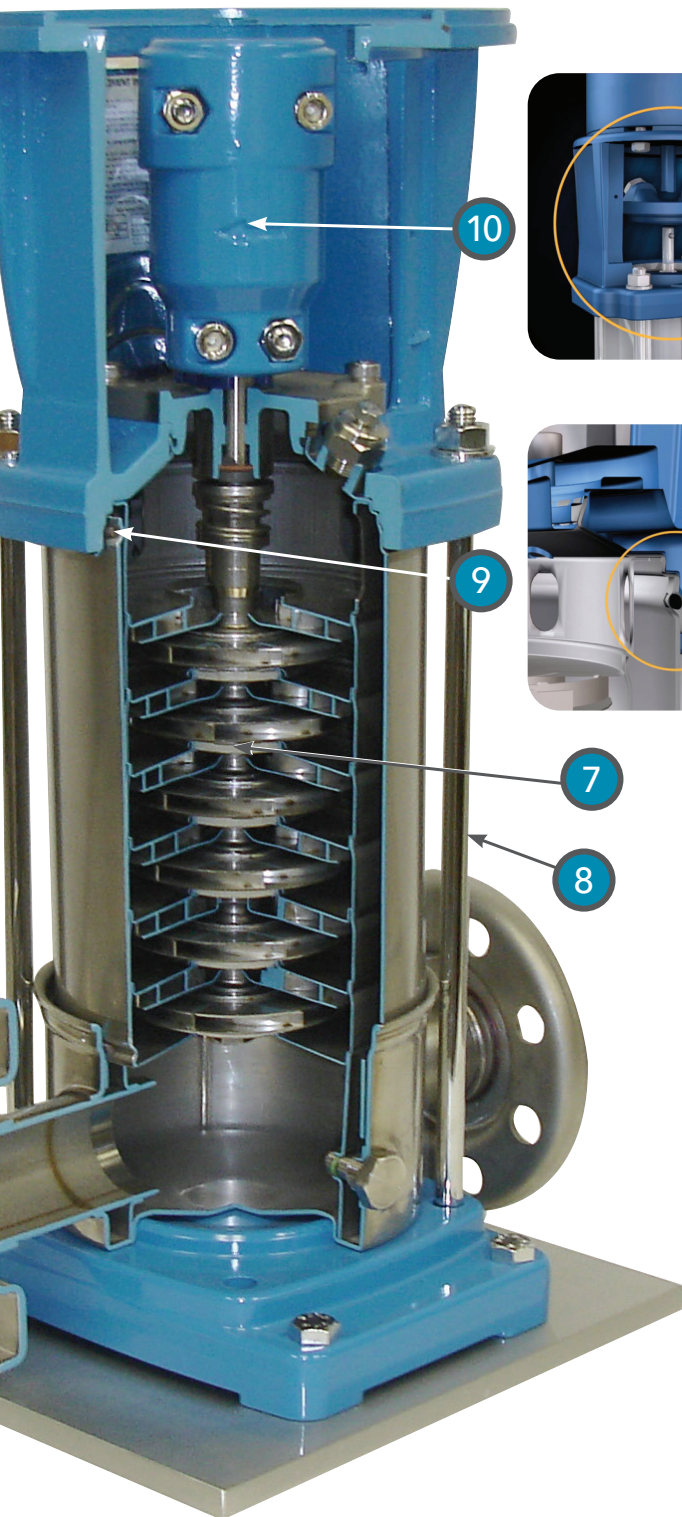

- 7. Impeller - The balanced impeller design reduces axial thrust for long standard motor bearing life.
- 8. Tie rods - The liquid end is held in place by tie rods, for increased stability.
- 9. O-ring - The seat design provides easy access and disassembly.
- 10. Mechanical seal - The seal is easy to replace without removing the motor. Robust seal options are available in a wide range of types and materials, to resist corrosion and minimize downtime in industrial and commercial building applications.

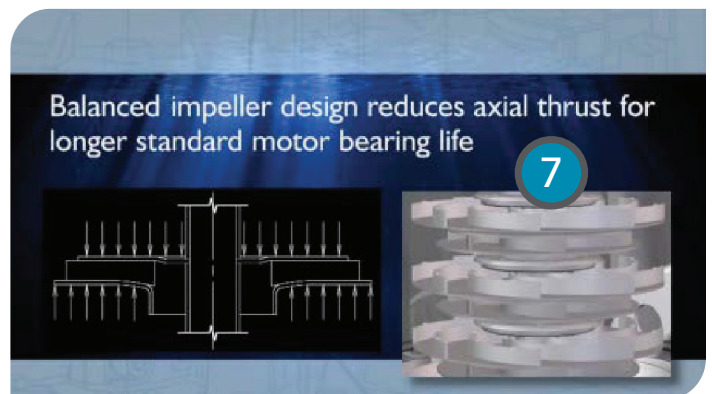

# Performance curves

## e-SV 60 Hz performance curves

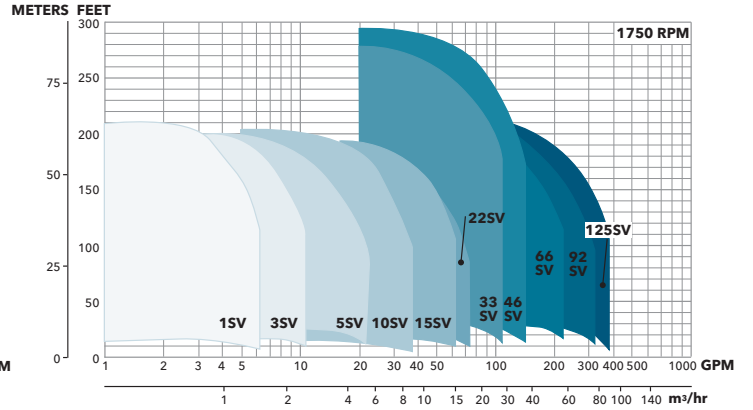
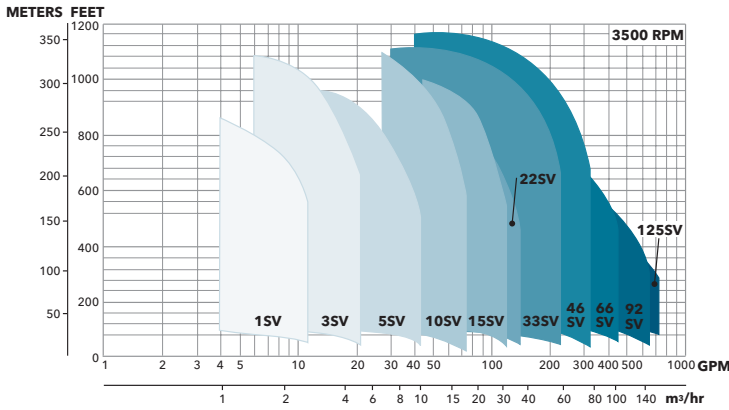

## e-SV 50 Hz performance curves

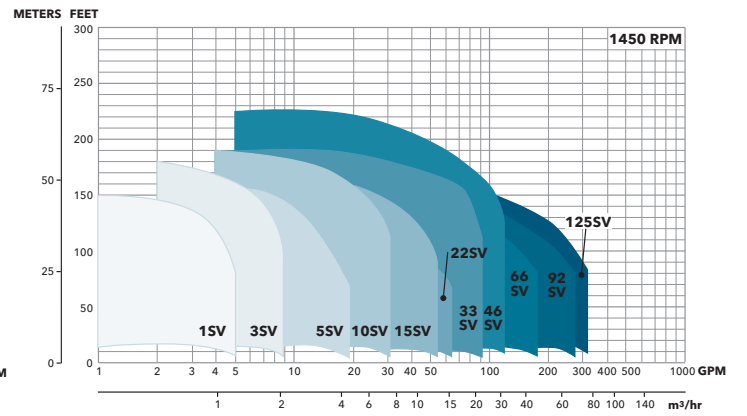
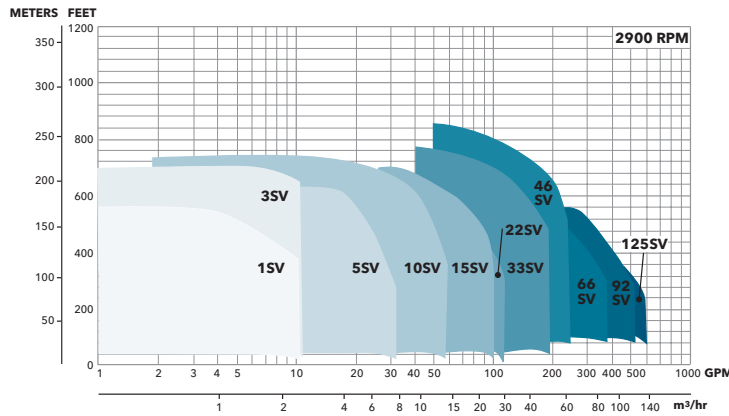



# Applications

e-SV multistage pumps have a history of performance handling water and liquids such as glycol, oils/solvents, and more in the industrial, municipal, commercial building services and agricultural markets. Some of the many applications include:



**WATER UTILITIES**

- Ultra-filtration systems
- Filtration
- Reverse osmosis systems
- Purification
- Water softeners and de-mineralization
- Distillation systems
- Booster systems
- Water transport/treatment systems
- Cooling and heating systems



**COMMERCIAL BUILDING SERVICES**

- Water transport
- Water networks
- Pressure booster systems (plants, buildings/hotels, residential complexes)
- Booster packages
- Potable water
- Firefighting system jockey pumps
- Heating, Ventilation and Air Conditioning
  - Cooling towers and systems
  - Temperature control systems
  - Refrigerators
  - Induction heating
  - Heat exchangers
  - Boilers
  - Water recirculation and heating



**GENERAL INDUSTRIAL**

- Pressure booster systems/boosting applications
- Commercial washers
- Water transport
- Potable water
- Washing and cleaning systems
- Large vehicle washing systems
- Process cooling and heating
- Machine tool cooling
- Electronics cooling
- Wash-down/clean-in-place
- Industrial fluid transfer and transport
- Heat transfer fluids
- Firefighting system jockey pumps
- Sprinkler systems
- Auxiliary applications



**POWER GENERATION**

- Boiler feed
- Boiler feed booster
- Cooling and heating systems
- Auxiliary system



**AGRICULTURE**

- Water transport
- Humidifiers
- Sprinkler/Irrigation (farm/golf/greenhouse/water fountains)

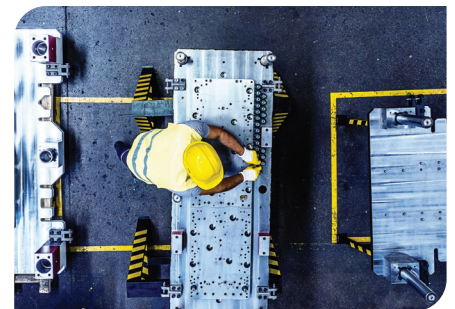

**OEM INDUSTRIAL**

- Water boosting
- Boiler feed
- Commercial cleaning
- Reverse osmosis

# e-SVE Smart Pumps

It's time to think beyond single components. For top efficiency in residential, light commercial, industrial, agricultural and OEM water supply and HVAC applications, you need the right combination of 1) motors; 2) variable speed drives; and, 3) hydraulic pumps – ensuring reliable performance, maximum savings and a rapid return on investment. The pre-programmed e-SVE Smart Pumps combine those three essential components in an easy to install package – so you benefit from the power, intelligence and performance of the Smart Pump Range right out of the box!

So, when it's time to think efficiency ... start with the e-SVE Smart Pumps from Goulds Water Technology - a complete system, delivering market-leading efficiency and performance.

## Typical example of increased performance

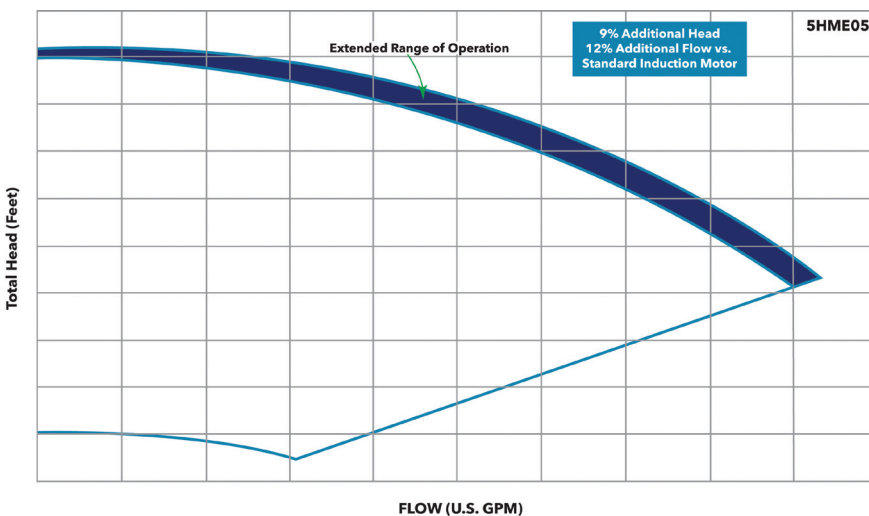

# Complete systems delivering market-leading efficiency and performance

## Benefits

- Features the Xylem Smart Motor an “ultra-premium” IE5 permanent, magnet motor, providing efficiency well above a standard IE3 an asynchronous motor.
  - includes a wide range of monitoring, control and safety features right out of the box with no need to configure.
  - can operate single or multipump systems of up to three pumps, with no need for an external control panel or PLC.
  - exceeds hydraulic performance of fixed speed versions in a more compact design.
- Six e-SVE pump ranges are available with multiple construction designs offer flexibility for a wide list of applications, including residential and light commercial, OEM applications and HVAC.
- A variety of connections (threaded, round, clam and oval flanges, Victaulic) configured vertically; ports can be on the same side to save space.
- Designed for fast, easy maintenance with a balanced mechanical seal, an O-ring seat design and a replaceable diffuser wear ring.
- Reduced impeller axial thrust for longer standard motor bearing life.
- Certified to the NSF/ANSI 61 Drinking Water System Components Standard.
- Options include high-temperature seals, low NPSH design, high pressure design, and passivated and electropolished versions.

## e-SVE Smart Pump specifications

- Delivery: Up to 85 GPM (19m<sup>3</sup>/h) max
- Head: Up to 710 feet (215m)
- Liquid temperature: Up to 250°F (120°C)
- Maximum operating pressure:
  - SV1-10 with oval flanges: 230 psi (16 bar)
  - SV1-10 with round flanges or Victaulic: 360 or 575 psi (25 or 40 bar)
- Power range: 0.5-3 HP (0.37 - 2.2 kW)

## e-SVE Smart Pump performance curves

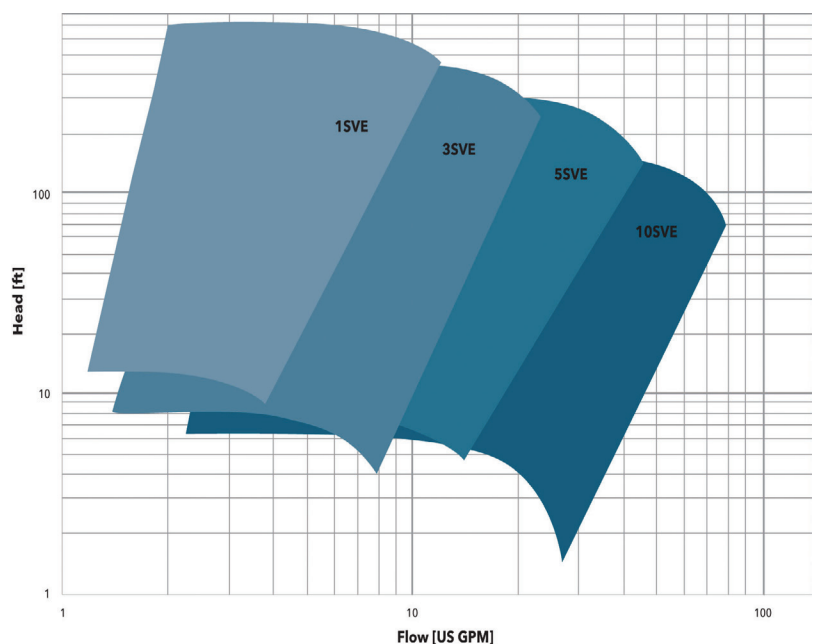

# e-SV Packaged HYDROVAR

The HYDROVAR variable speed pump drive takes pumping to a new level of flexibility and efficiency when combined with the e-SV pump, one of the highest efficiency multistage pumps on the market today. The Packaged HYDROVAR ships as one complete unit comprised of an e-SV pump, a HYDROVAR drive and a fused disconnect. It arrives pre-assembled, pre-wired and pre-programmed. The Packaged HYDROVAR is designed for centrifugal pump systems requiring constant pressure, flow control or differential pressure.



## e-SV Packaged HYDROVAR coverage chart

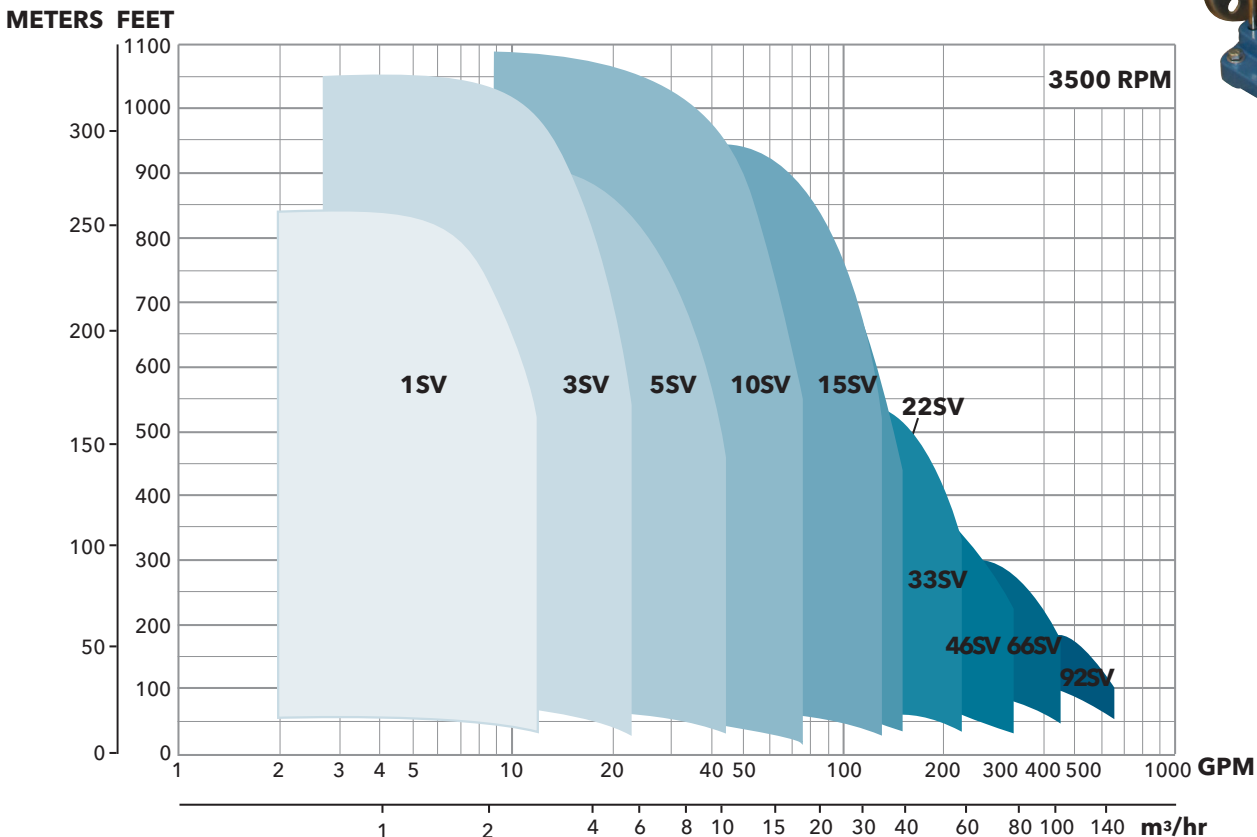

**NOTE:** Refer to e-SV technical brochure and/or the selection software for final e-SV pump selection.

# Variable speed water booster with vertical multistage pump and fused disconnect providing industry-leading efficiencies

## Benefits

- The Packaged HYDROVAR provides industry-leading efficiencies with a broad performance range.
- The vertically-mounted configuration of e-SV pump, motor and HYDROVAR drive is designed to save space.
- The components are pre-sized and pre-selected, which simplifies the ordering process.
- The system is assembled, programmed and tested in the factory.
- It's quickly installed as single unit. Just bring power.
- The system has the capability to control up to eight pumps.
- It's designed for centrifugal pump systems requiring constant pressure, flow control or differential pressure.
- It features NEMA 1 for indoor use.
- Kits are available, and offer a pre-wired drive and fused disconnect to retrofit pumps in the field.
- It has a UL package listing.

## Specifications

- Flow rate: up to 725 GPM
- Head: up to 1,080' TDH
- Input supply: 1Ø Input 208/230 volt 2 - 5 HP  
3Ø Input 208/230 volt 2 - 15 HP  
3Ø Input 460 volt 2 - 30 HP  
(208 - 240V ± 10%, 15 - 70 Hz)  
(380 - 460V ± 10%, 15 - 70 Hz)
- Output voltage: 3Ø, 230V 2 - 15 HP  
3Ø, 460V 2 - 30 HP
- Input frequency: 50 or 60 Hz
- External control voltage: 0-5 VDC; 0-10 VDC; 0-20 mA
- Protection class: panel: NEMA 4X  
drive: NEMA1 up to 30 HP
- Maximum HP: 30 HP
- Soft motor start
- Vertical design pump: e-SV series (motor insulation class, °F, TEFC enclosure)
  - Maximum operating pressure: 360 PSI
  - Maximum temperature of pumped liquid: 250°F

# Make your e-SV even more efficient

There are significant opportunities to reduce a pumping system's energy consumption, including smart hydraulic system design, efficient operating practices, and retrofitting for variable speed performance. To build and operate an efficient water system, you need both the right products and experts who know the application.

HYDROVAR and AQUAVAR IPC controllers were designed by Xylem's engineers with these things in mind. They incorporate built-in pump protection controls and monitoring, to help you optimize your pump operations. What's more, when combined with efficient e-SV Series pumps, they increase your energy savings up to 70% vs. fixed speed while reducing installation time.

## AQUAVAR® IPC variable speed controller

### Features

- The Start-Up Genie makes start-up and programming easy.
- A wide range of standard and permanent magnet motors provide power up to 600 hp.
- AQUAVAR can control up to four pumps, with no need for a programmable logic controller.
- It can be commissioned and monitored remotely, and includes USB connectivity and software.
- The two-wire multi-pump connection makes installation quick and easy.



- Hand on, off, and auto-on buttons are available for easy pump operation at the keypad. No need to toggle between local and remote operation.
- It includes system redundancy with multi-master control, in case of drive failure.
- BACnet and MODBUS are standard, for seamless BMS integration.

### Specifications

- **Indoor enclosures:** IP20 open, Type 1, Type 12
- **Outdoor enclosures:** Type 3R, Type 4X
- **Input supply:** 1.5 - 600 HP (frame A - D) wall or base mounted
- **Ambient temperature:** 14° F - 113° F (-10°C - 45°C); Higher temperatures can be achieved by derating the output amperage of the drive 10% for up to 122° F (50°C).
- **Communication:** MODBUS® RTU, Metasys N2, FLN, and BACnet standard. Others available with option cards
- **Relative humidity:** Lower than 95% without condensation
- **Altitudes:** At altitudes from 0 to 1000 meters (0 to 3300 feet). Nameplate rated current is available. Derate for altitudes above 1000 (3300 feet) with a maximum operating altitude of 3000 meters (9900 feet). Consult factory for applications above 3000 meters (9900 feet).
- **Electrical - input power:**
  - 1 phase 200 V to 240 V ±10%
  - 3 phase 380 V to 480 V ±10%
  - 3 phase 200 V to 240 V ±10%
  - 3 phase 525 V to 600 V ±10%
  - Frequency 50 or 60 Hz, ±2Hz
- **Electrical - output power:** 3 phase from 0 to V supply

# HYDROVAR®

## pump mounted variable speed controller



### Features

- Pre-programming for standard motors
- Twenty-eight (28) language sets
- Optional Wi-Fi card for the flexibility of wireless connection
- Advanced motor control to reduce heating and extend the lifetime of the motor
- Embedded THDi filter for better electricity quality from the grid, extending the lifetime of the equipment
- Standard multi-pump capability of up to eight (8) pumps with no single failure point
- Premium card option for extended I/O
- Backward compatibility to existing HYDROVAR products
- BACnet and MODBUS as a standard for seamless BMS integration

### Specifications

- **Input supply (from 2 hp to 30 hp):**
  - 1Ø Input 208/230 V 2 - 5 HP (208-240 V ± 10%)
  - 3Ø Input 208/230 V 2 - 15 HP (208-240 V ± 10%)
  - 3Ø Input 460 V 2 - 30 HP (380-460 V ± 10%)
- **Speed:** from 15-70 Hz
- **Power supply:** single or three phase 50 or 60 Hz
- **Motor requirements:** 3 phase, TEFC, 208 - 230 V or 460 V, 0 - 60 Hz, Class F insulation, NEMA design A or B. Motor to fan cover of TEFC motor for a packaged unit with a small footprint.
- **Maximum ambient temperature:** 104° F
- **Indoor enclosure:** NEMA 1. Avoid excessive dust, corrosives, salts and direct sunlight.
- **Communication:** RS485 interface, BACnet, MODBUS

## Expert support

The proper selection and configuration of your pump is critical to long-term efficiency and dependability. So give us a call. Our experienced customer service technical support team will ensure that your pump is optimized for your application, and designed to deliver the long-lasting, reliable service that you expect.

## Online selection tool

Simplify the selection process with Intellitronic X, our user-friendly online selection tool. Easily configure your pump based on your application. We'll assemble it and send it on its way. Get started at [www.gouldsintellitronic.com](http://www.gouldsintellitronic.com).

## Xylem |'zīləm|

- 1) The tissue in plants that brings water upward from the roots;
- 2) a leading global water technology company.

We're a global team unified in a common purpose: creating advanced technology solutions to the world's water challenges. Developing new technologies that will improve the way water is used, conserved, and re-used in the future is central to our work. Our products and services move, treat, analyze, monitor and return water to the environment, in public utility, industrial, residential and commercial building services settings. Xylem also provides a leading portfolio of smart metering, network technologies and advanced analytics solutions for water, electric and gas utilities. In more than 150 countries, we have strong, long-standing relationships with customers who know us for our powerful combination of leading product brands and applications expertise with a strong focus on developing comprehensive, sustainable solutions.

**For more information on how Xylem can help you, go to [www.xylem.com](http://www.xylem.com)**



Xylem Inc.  
Phone: (866) 673-0428  
Fax: (888) 322-5877  
[www.xylem.com/goulds](http://www.xylem.com/goulds)

Xylem, AQUAVAR, and HYDROVAR, are trademarks of Xylem Inc. or one of its subsidiaries. Goulds is a registered trademark of Goulds Pumps, Inc. and is used under license. MODBUS is a registered trademark of Schneider Electric USA, Inc.  
© 2022 Xylem Inc. BROeSV R5 June 2022