

PACO KP, KPV

Split case pump
60 Hz

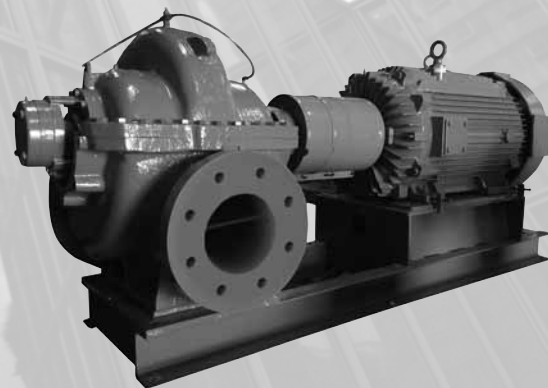

1. Features and benefits	3	7. Curve charts and technical data	21
Nameplate	3	How to read the curve charts	21
2. Applications	4	Curve conditions	22
Commercial systems	4	Performance tests	22
Industrial systems	4	Witness test	22
Water distribution	4	KP 2095-1/2 [2-pole]	23
Irrigation and aquaculture	4	KP 3095-7/8 [2-pole]	24
3. Product range	5	KP 4012-1/2 [2-pole]	25
Pump configurations	5	KP 4012-7/8 [2-pole]	26
4. Performance range	6	KP 2095-1/2 [4-pole]	27
KP 2-pole	6	KP 2013-5/6 [4-pole]	28
KP 4-pole	7	KP 3095-7/8 [4-pole]	29
KP 6-pole	8	KP 3014-7/8 [4-pole]	30
5. Construction	9	KP 4012-1/2 [4-pole]	31
KP pump, construction X2	9	KP 4012-7/8 [4-pole]	32
KP pump, construction X4	10	KP 4015-9/0 [4-pole]	33
KP pump, construction X5 and X7	11	KP 5012-7/8 [4-pole]	34
KP pump, construction XK and XV	12	KP 5015-9/0 [4-pole]	35
KP pump, typical end view - Horizontal	13	KP 6012-3/4 [4-pole]	36
Std. components and material specification	14	KP 6015-3/4 [4-pole]	37
Mechanical construction	15	KP 6019-7/8 [4-pole]	38
6. Operating conditions	18	KP 6020-3/4 [4-pole]	39
Ambient temperature and altitude	18	KP 8012-5/6 [4-pole]	40
Liquid temperatures and shaft seals	18	KP 8015-3/4 [4-pole]	41
Shaft seal	18	KP 8020-5/6 [4-pole]	42
Pressure	18	KP 1012-1/2 [4-pole]	43
Flow	19	KP 1015-3/4 [4-pole]	44
KP Impeller Max Sphere Size	19	KP 1020-3/4 [4-pole]	45
KP model number and construction code	20	KP 1024-3/4 [4-pole]	46
		KP 1415-1/2 [4-pole]	47
		KP 6019-7/8 [6-pole]	48
		KP 6020-3/4 [6-pole]	49
		KP 8015-3/4 [6-pole]	50
		KP 8020-5/6 [6-pole]	51
		KP 1012-1/2 [6-pole]	52
		KP 1015-3/4 [6-pole]	53
		KP 1020-3/4 [6-pole]	54
		KP 1024-3/4 [6-pole]	55
		KP 1220-5/6 [6-pole]	56
		KP 1415-1/2 [6-pole]	57
		8. Bare shaft pump	58

1. Features and benefits

The Paco KP horizontal split case pump and KPV vertical split case pump are single stage, centrifugal volute pumps with high energy efficiency and low life-cycle costs.

Ease of service and long-term reliability are two of the selling features of the KP pumps. The split case design enables removal and dismantling of the internal pump parts (bearings, wear rings, impeller, and shaft seals) without disturbing the motor or pipe work. The two-bearing design means less vibration and higher reliability. The separate bearing housings allow for inspection of the seals, sleeves and bearings without removing the top half of the casing.

The double-suction design reduces axial forces by directing flow into both sides of the impeller. The double-volute design, available on most models, reduces the radial load and minimizes noise and vibration. Shaft sleeves are used to protect the shaft from corrosion and wear, thus extending the overall life of the shaft and the pump.

KP pumps cover this performance range:

- Flow rate: 60 to 12000 gpm [10 to 2700 m³/h]
- Head: 15 to 700 ft [5 to 215 m]
- Motor (P2): 10 to 2000 hp

The pumps are non-self-priming, centrifugal volute pumps with radial suction and radial discharge ports and horizontal shaft. Impellers are hydraulically balanced.

Paco KP pumps are available in these different options:

- Pump with motor and base (see fig. 1).
- Bare shaft pump, i.e. pump without motor, with base (see fig. 2).
- Bare shaft pump, i.e. pump without motor, without base (see fig. 3).
- Or any combination requested by the customer

KPV pumps

- Same great features of KP, but in a vertical configuration for optimized space savings
- Optional lower sleeve bearing design for easier lower bearing maintenance.

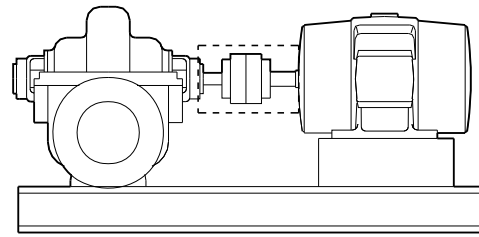

Fig. 1 KP pump with motor and base

TM04 7331 1910

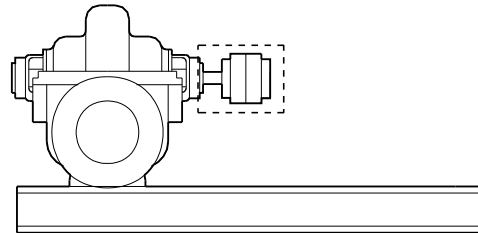

Fig. 2 KP bare shaft pump with base, coupling, and guard

TM05 5003 2712

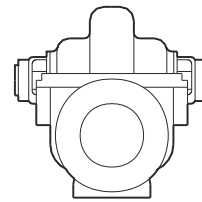

Fig. 3 KP bare shaft pump

TM05 5875 3912

Nameplate

PACO PUMPS			
CAT#: 29-40159-140001-1952EE			
STOCK#: 98173512			
SER#: 1971071543-10			
GPM: 650	TDH: 192	IMP DIA: 13.44	”
MFD BY GRUNDFOS CBS INC			34014412

TM05 7638 1313

2. Applications

The Paco KP pumps are used in these main fields of application:

- commercial systems
- industrial systems
- water distribution
- irrigation.

Commercial systems

Liquid transfer and pressure boosting in:

- air conditioning, primary and secondary chilled water systems
- water condensing systems and cooling towers
- boiler feed and condensate systems
- district heating plants and heating systems
- swimming pools
- fountains.

Industrial systems

Liquid transfer and pressure boosting in:

- process cooling and chilled water systems
- water condensing systems and cooling towers
- boiler feed and condensate systems
- industrial heating systems
- wash down and cleaning systems
- industrial processing systems (water, light chemicals, oils, etc).

Water distribution

Liquid transfer and pressure boosting in:

- public waterworks
- non-potable water systems.

Irrigation and aquaculture

Irrigation covers these applications:

- field irrigation (flooding)
- sprinkler irrigation
- drip-feed irrigation
- aqua farming.

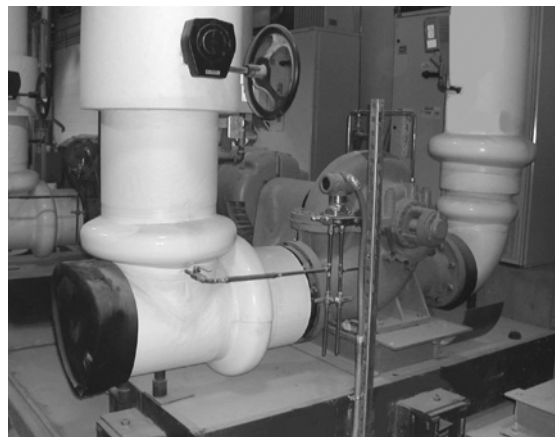

TM05 5977 4012

Fig. 4 KP pump used in commercial building applications



GR 2910

Fig. 5 KP pump in sprinkler irrigation

3. Product range

Pump configurations

	Standard configuration	Optional configuration
Pump casing	Cast Iron	Ductile Iron
Impeller	Bronze	<ul style="list-style-type: none"> • Cast Iron • Aluminium bronze • Stainless steel
Sleeve	Bronze	Stainless steel
Coupling	<ul style="list-style-type: none"> • Elastomeric • Grid 	Spacer Coupling
Shaft seal	Mechanical seal:	Soft packing
Flange	ANSI 125	ANSI 250
Flushing line	None	<ul style="list-style-type: none"> • Nylon • Copper • Stainless Steel
Wear rings	Bronze	Stainless Steel
Shaft	Steel	Stainless Steel
Motor efficiency class	NEMA Premium	Others on request
Pump direction of rotation	CW - clockwise	CCW - counter clockwise

To a great extent the pumps can be adapted to the requirements of the individual customer. For customized solutions, contact your local Grundfos company.

4. Performance range

Paco KP pumps are available with 2-, 4- or 6-pole motors. 8 and 10 pole are available on request.

The next three pages show the performance range covered by these three motor types.

Knowing your required duty point, use the performance ranges like this:

1. Go into the relevant performance range chart.
2. Find your duty point.
3. Note which pump type covers your duty point.
4. Go to section "Product range" and then to "Performance curves and technical data" and find more detailed information on your chosen pump.

KP 2-pole

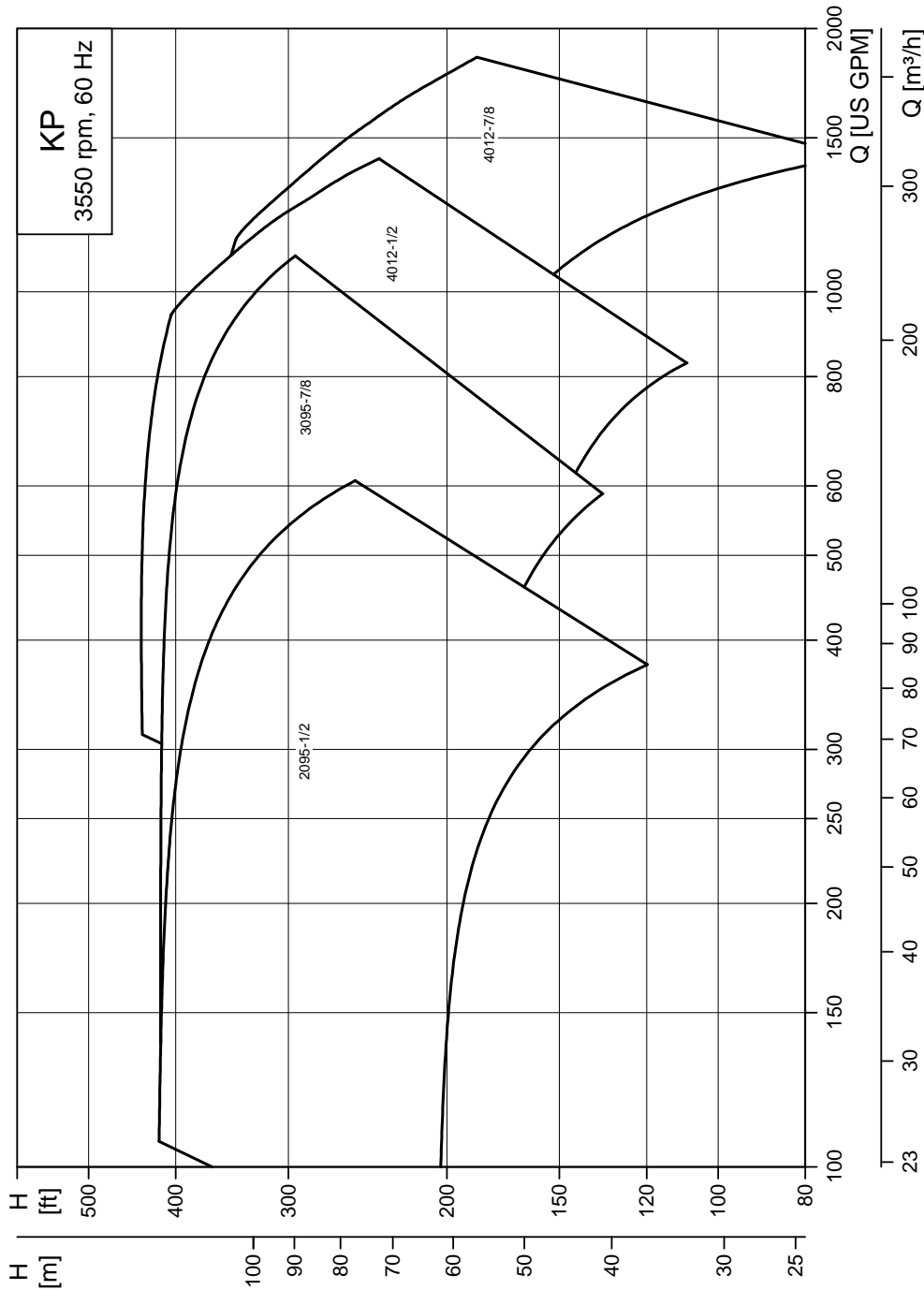

TM05 5045 3812

KP 4-pole

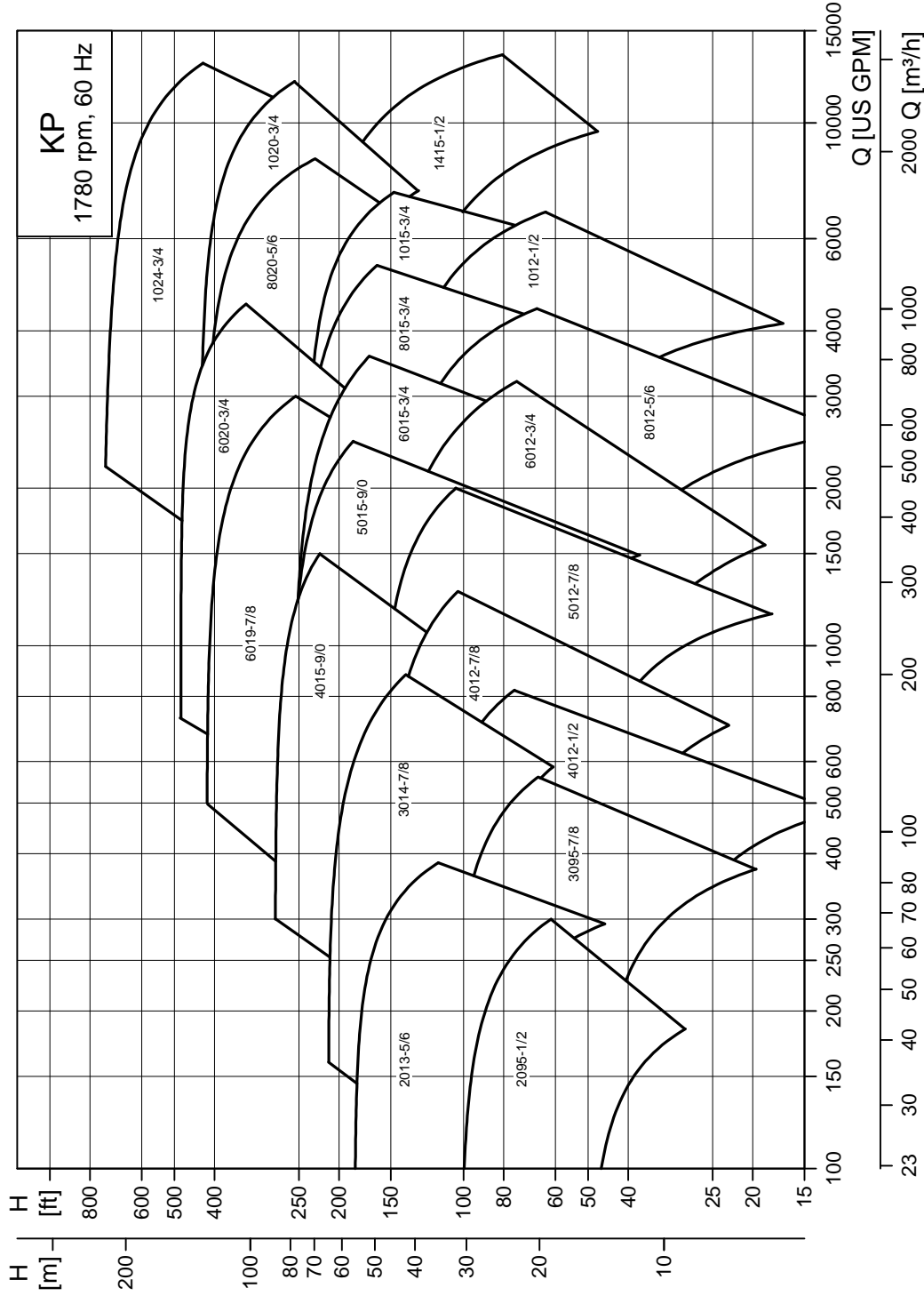

TM05 5978 3812

KP 6-pole

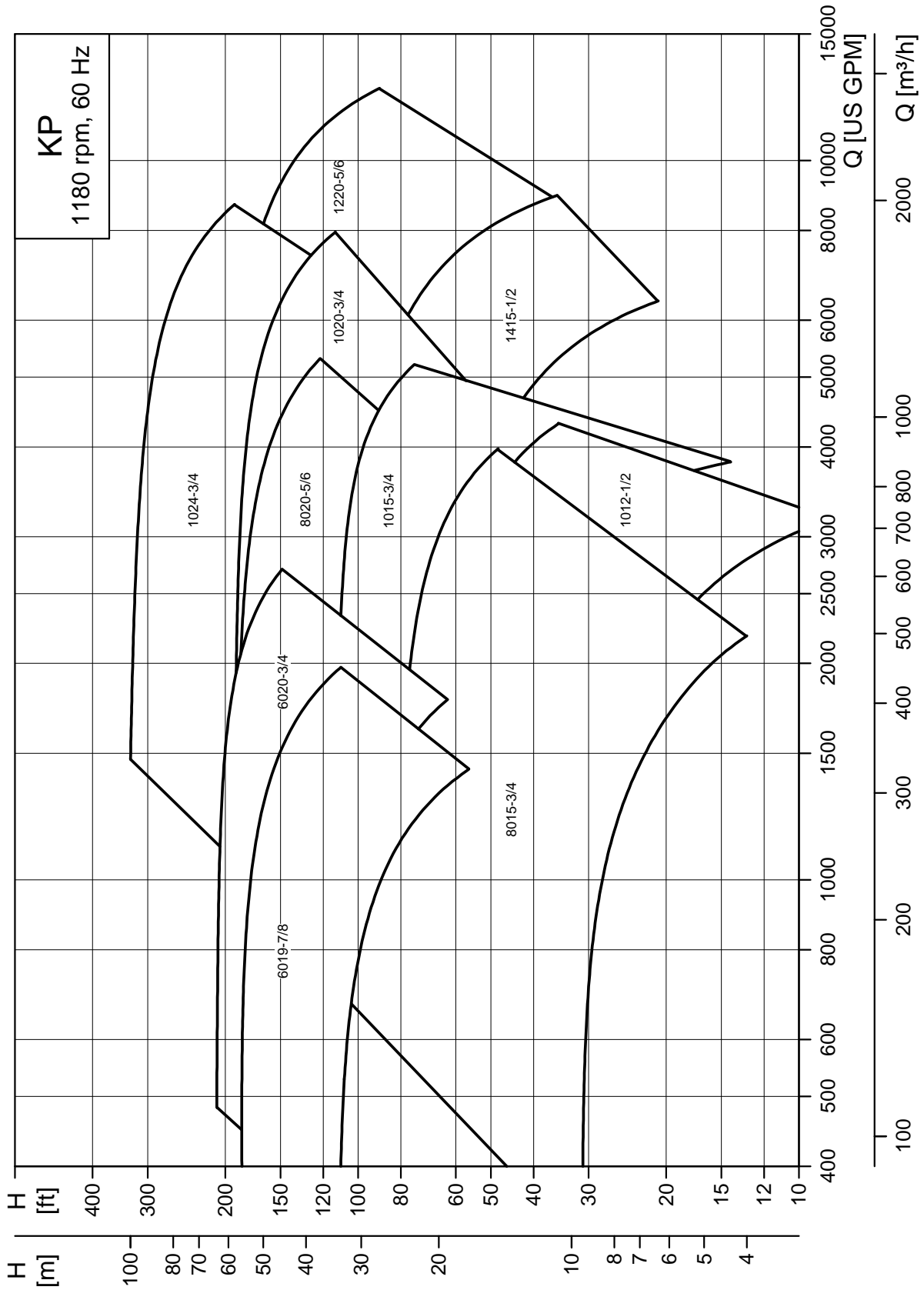

TM05 5047 3812

5. Construction

Paco KP horizontal split case pumps are available in several different construction types.

KP pump, construction X2

All four construction types are available with packing as an option.

Sectional view

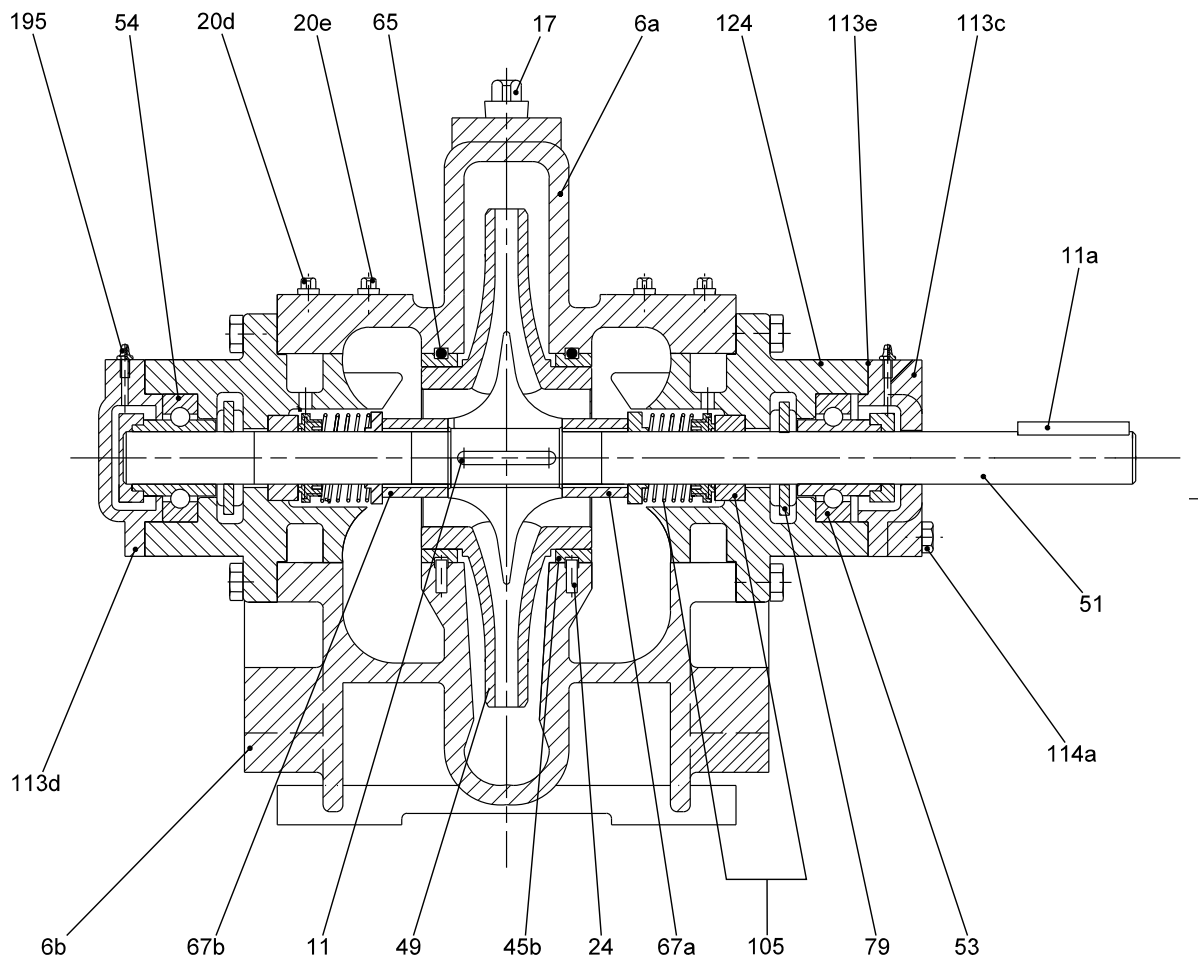

TM03 9952 4707

Fig. 6 Sectional view, construction X2, with mechanical shaft seals

KP pump, construction X4

Sectional view

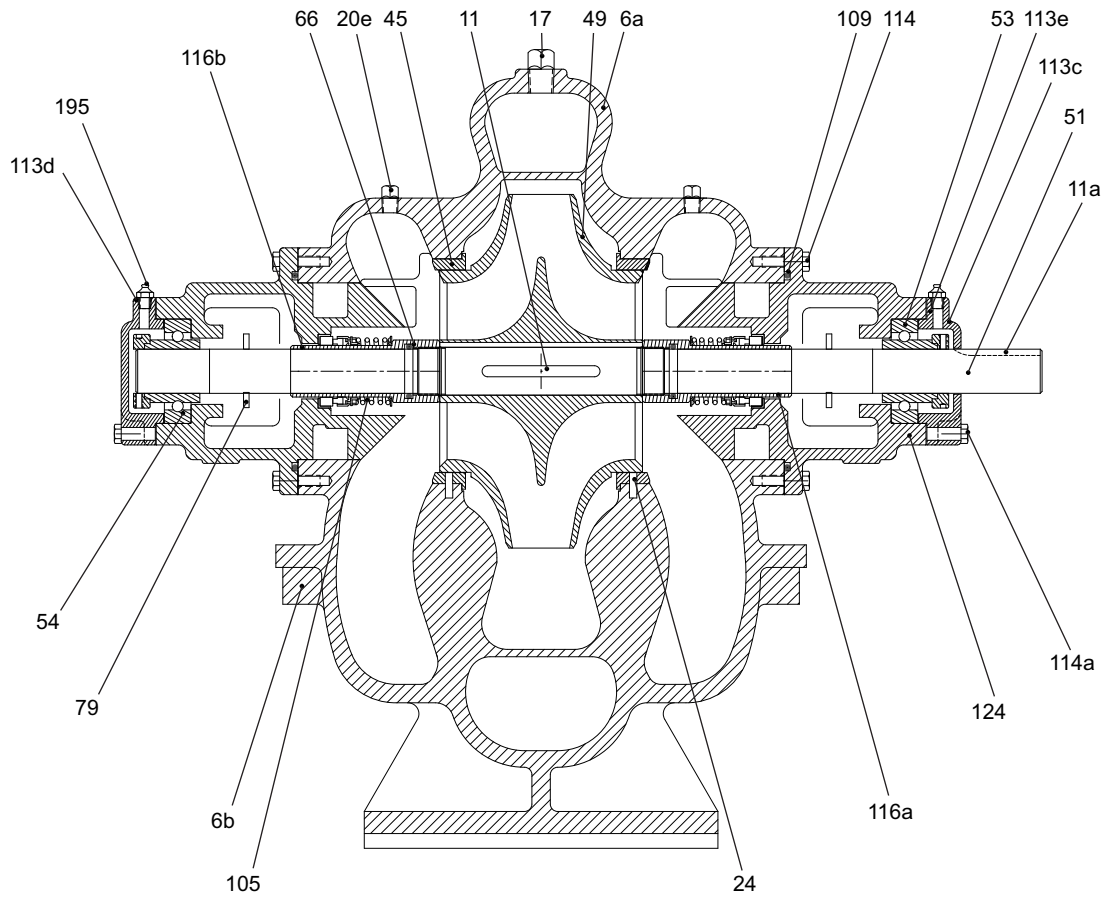
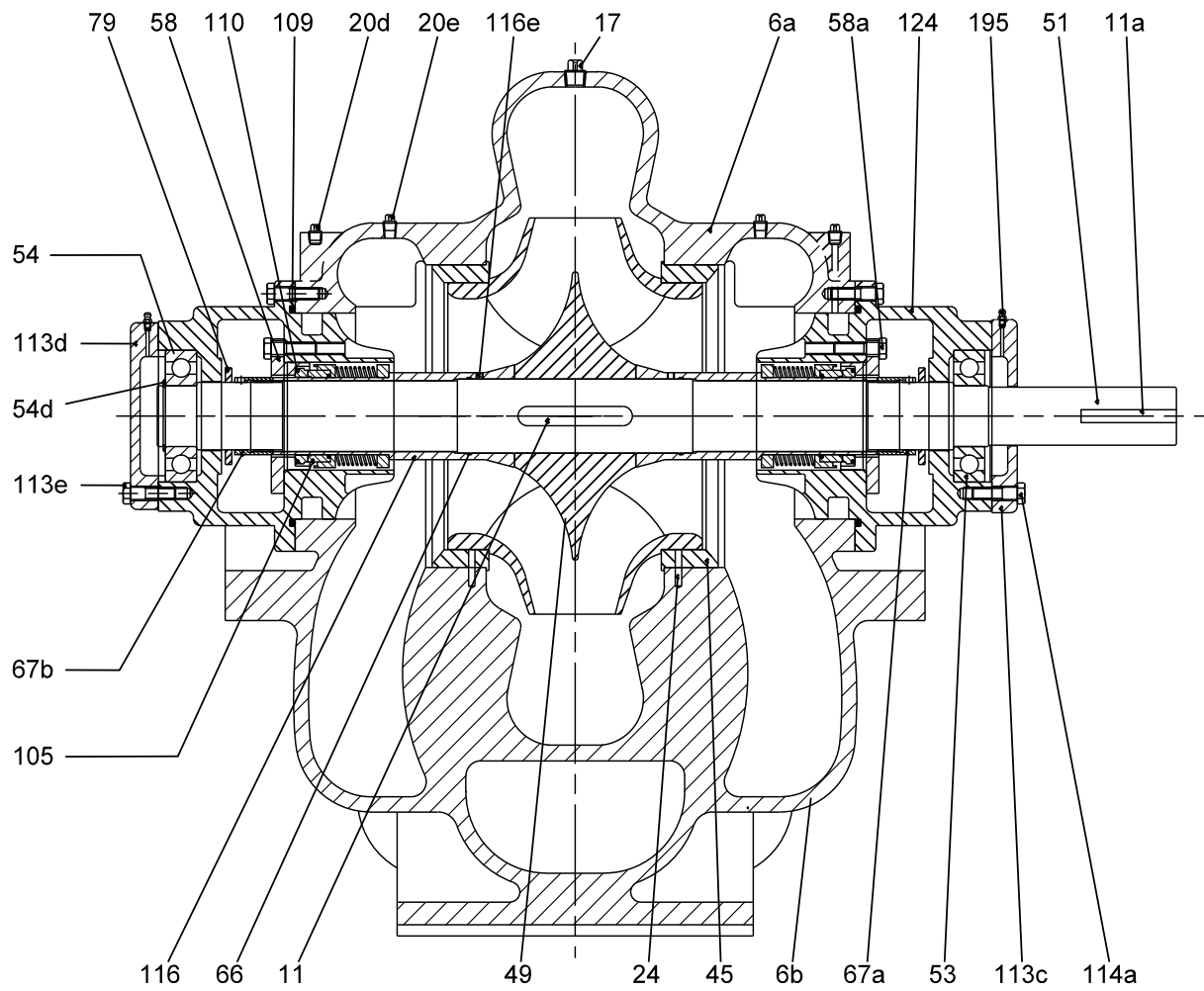

Fig. 7 Sectional view, construction X4, with mechanical shaft seals

TM05 7482 1013

KP pump, construction X5 and X7

Sectional view



TM03 9954 4707

Fig. 8 Sectional view, construction X5/X7, with mechanical shaft seals

KP pump, construction XK and XV

Sectional view

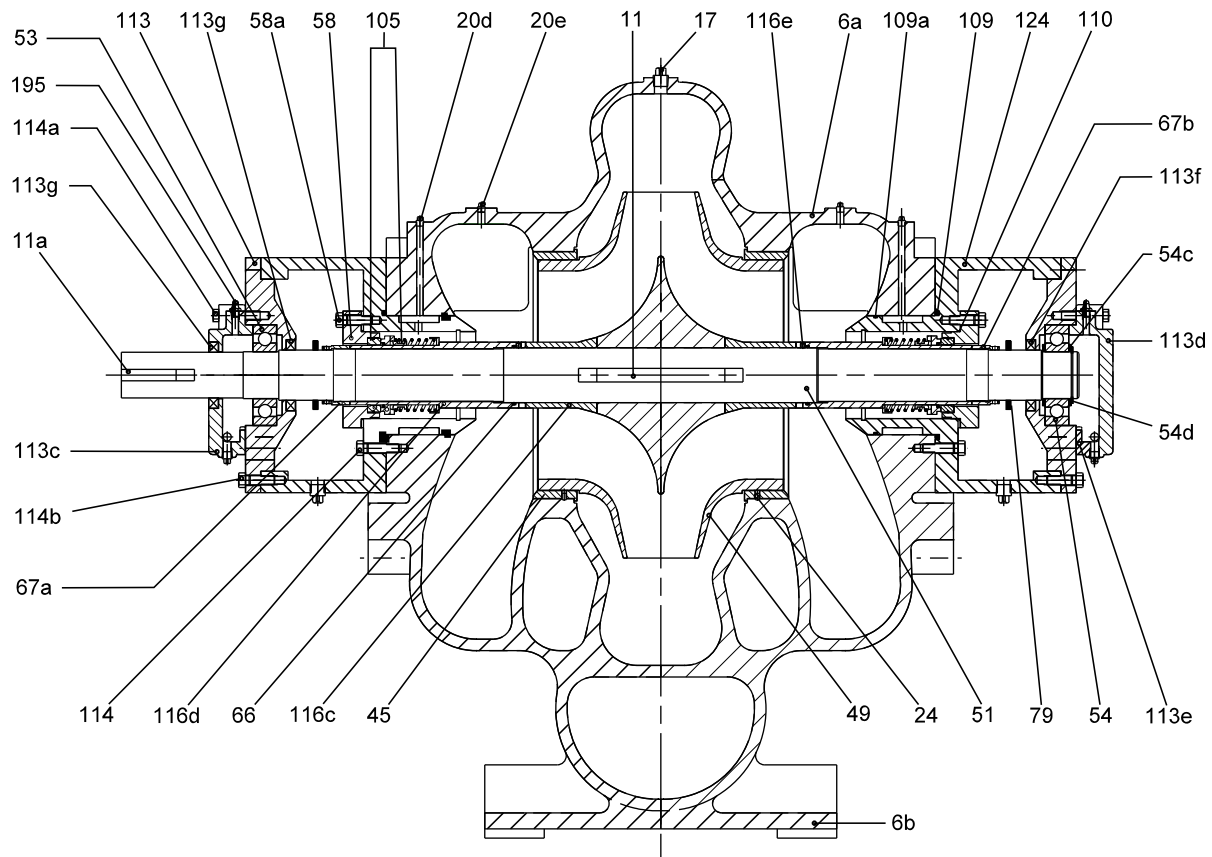
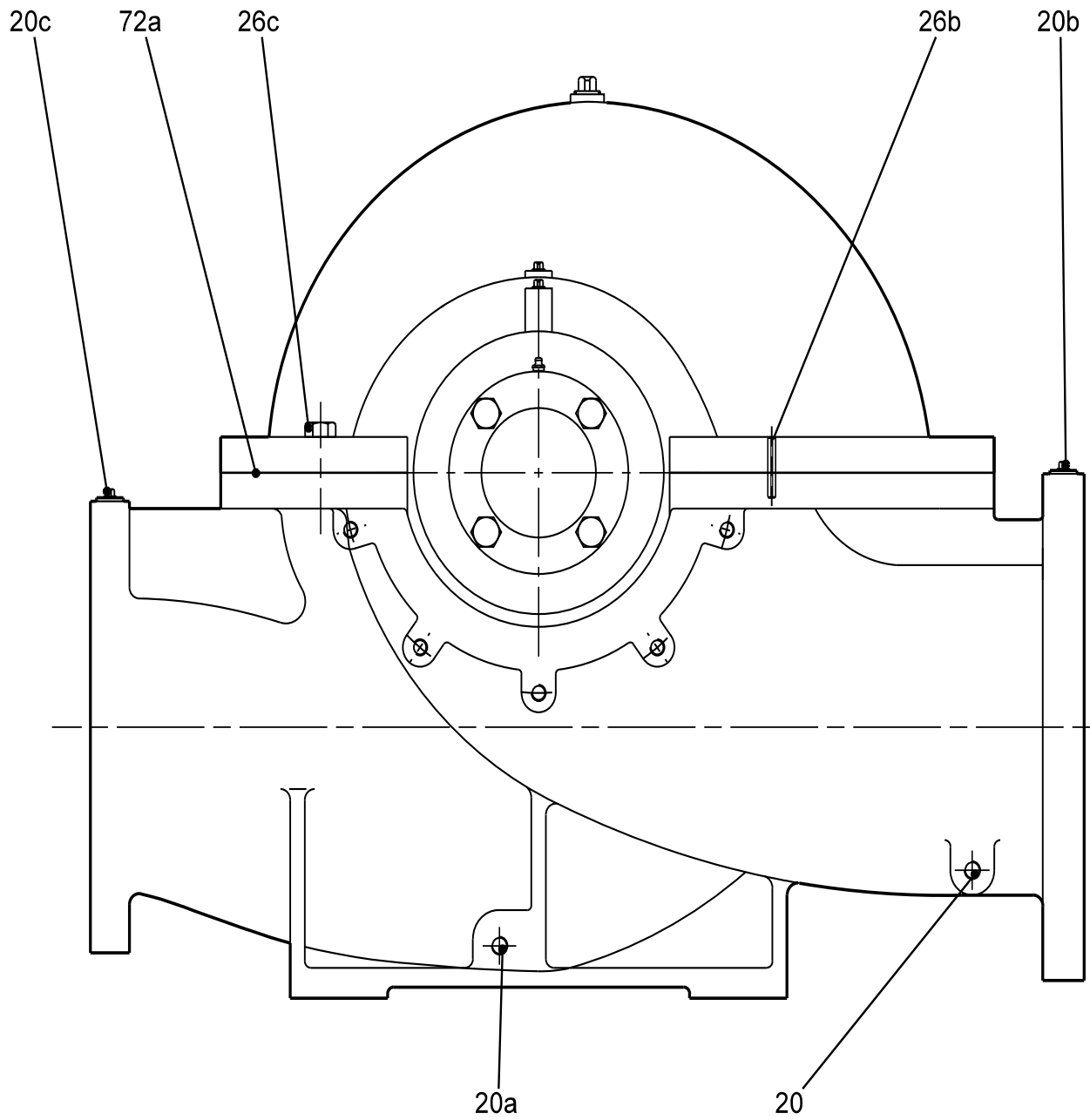

Fig. 9 Sectional view, construction XK/XV, with mechanical shaft seals

TM03 9955 4707

KP pump, typical end view - Horizontal

(Non-drive end)



TM04 1864 1108

Fig. 10 Typical end view (non-drive end)

Std. components and material specification

Pos. no.	Component	Material	ASTM standard
6a	Pump casing, upper	Cast Iron	ASTM A48 CL35
6b	Pump casing, lower	Cast iron	ASTM A48 CL35
11	Key, impeller	Steel	C1018, cold drawn steel
11a	Key, coupling	Steel	C1018, cold drawn steel
17	Pipe plug	Steel	
20	Drain plug R 1/2	Steel	
20a	Plug, drain outlet	Steel	
20b	Plug, inlet	Steel	
20c	Plug, outlet	Steel	
20d	Plug, shaft seal flushing	Steel	
20e	Plug, suction chamber	Steel	
24	Locking pin, wear ring	Steel	ANSI/ASME B18.8
26b	Roll pin	Steel	ANSI/ASME B18.8
26c	Screw	Steel	
45	Wear ring	Bronze	ASTM B148, C95200
45b	Wear ring with groove for retaining ring	Bronze	ASTM B148, C95200
49	Impeller	Silicon bronze	ASTM B584, C87600
51	Shaft	Steel	AISI 1144 Stress proof
53	Ball bearing, drive end	Steel	
54	Ball bearing, non-drive end	Steel	
54c	Washer	Steel	
54d	Retaining ring	Carbon Spring Steel	SAE 1060-1090
58	Seal cover	Grey Iron	
58a	Screw	Steel	
65	Retaining ring	Stainless steel, series 303	
66	O-ring	NBR	
67a	Impeller/shaft sleeve nut, right-hand thread	Bronze	III932, C89835
	Impeller/shaft lock nut, right-hand thread	Stainless steel	
67b	Impeller/shaft sleeve nut, left-hand thread	Bronze	III932, C89835
	Impeller/shaft lock nut, left-hand thread	Stainless steel	
72a	Gasket	Vegetable fiber (HYD-401)	
76	Nameplate	Aluminum	
79	Slinger	Neoprene	
105	Shaft seal		
109	O-ring	NBR	
109a	O-ring	NBR	
110	O-ring	NBR	
113	Bearing housing	Cast iron	ASTM A48, CL30
113c	Bearing cover, drive end	Cast iron	ASTM A48, CL30
113d	Bearing cover, non-drive end	Cast iron	ASTM A48, CL30
113e	Gasket	Vegetable fiber	
113f	Lip seal, non-drive end bearing	NBR	
113g	Lip seal, drive-end bearing	NBR	
114	Screw	Steel	
114a	Screw	Steel	
114b	Screw	Steel	
116	Shaft sleeve	Bronze	III932, C89835
116a	Shaft sleeve, drive end	Bronze	I836 C89833
116b	Shaft sleeve, non-drive end	Bronze	I836 C89833
116c	Shaft sleeve, inner	Bronze	I836 C89833
116d	Shaft sleeve, outer	Bronze	I836 C89833
116e	Set screw	Steel	
124	Seal housing	Cast iron	ASTM A48 CL30
195	Lubricating nipple	Zinc coated steel	

Mechanical construction

Pump casing

The class 35 grey iron volute pump casing has radial suction port and radial discharge port.

The pumps are of the inline (symmetric) design.

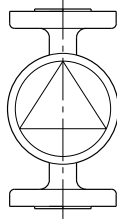

TM04 0476 0708

Fig. 11 Schematic drawing of an inline KP pump

Flange Drillings are in accordance with ANSI #125 or #250.

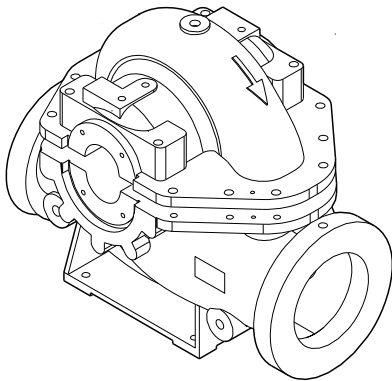

TM04 0475 0708

Fig. 12 Upper and lower pump casing of KP pump

Shaft

The shaft (pos. 51) is of the key and keyway type with one key for the impeller (pos. 11) and one key for the coupling (pos. 11a).

The shaft is supported by bearings at both the drive end and the non-drive end of the pump.

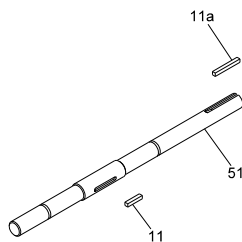

TM04 0477 0708

Fig. 13 KP pump shaft

Shaft sleeves are attached to the pump shaft to prevent wear of the shaft and secure the position of the impeller.

Bearings

KP pumps are fitted with two standard single-row deep-groove ball bearings. The bearings are of the open type permitting the bearings to be relubricated. The bearings are lubricated by Grundfos prior to delivery.

Seal housings

All KP pumps have two seal housings (pos. 124), one at the drive end and one at the non-drive end of the pump shaft.

A seal housing has several functions:

- Supports the pump sealing system, whether it is a mechanical shaft seal or packing
- Supports the bearing housing thus transmitting both radial and axial forces from bearing and shaft to the upper and lower pump casing
- Has a connection for the flushing pipe.
The function of the flushing pipe is to ensure a flow of pumped liquid for cooling and lubricating the mechanical shaft seal or the packing

Impeller

The KP impeller (pos. 49) is a closed double-suction impeller. The impeller has inflow of liquid from both sides and is locked in position by a threaded sleeve arrangement.

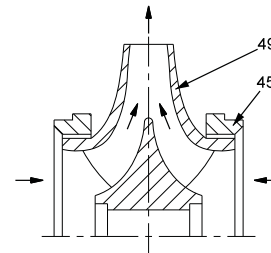

TM03 3891 1106

Fig. 14 Double-suction impeller

All impellers are dynamically balanced in accordance with ANSI/ISO 1940 Class G6.3 standard. Due to their design, the impellers are inherently hydraulically balanced and thus compensate for axial thrust.

All impellers are trimmed to the duty point required by the customer.

Wear rings

KP pumps have wear rings (pos. 45) between impeller and pump casing. As the name indicates, the wear rings protect the pump casing against wear. The wear rings act as a seal between impeller and pump casing. When the wear rings become worn, the efficiency of the pump will be reduced and the wear rings should be replaced.

Coupling

As standard, KP pumps are fitted with a flexible grid coupling or elastomeric coupling, depending on motor size. The grid coupling consists of two steel flanges horizontally split coupling halves.

The coupling design assists in reducing vibrations and cushions shock loads. The design also extends the life of the coupling itself. The flexible grid is standard for VFD driven pumps.



Fig. 15 Flexible grid coupling

The elastomeric coupling has a flexible rubber section to absorb vibrations and minimizes negative affects of misalignment.



Fig. 16 elastomeric coupling

Mechanical shaft seal

The material of the standard version is Buna Carbon/ ceramic.

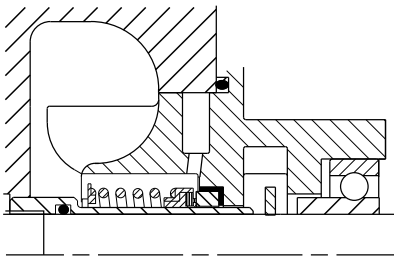

Fig. 17 Rubber bellows shaft seal

Packing

Includes graphite impregnated packing rings.

The packing rings consist of braided material which is effective for long service life for packing rings while protecting the shaft sleeve.

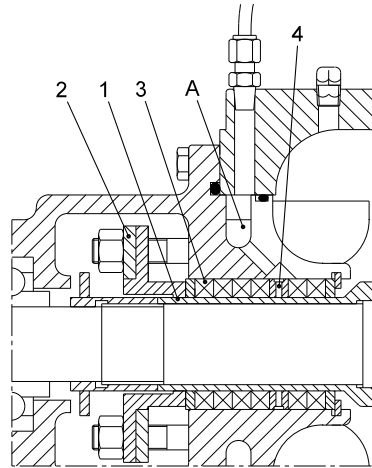

Fig. 18 Sectional view of packing with internal flushing liquid

Pos.	Description
1	Shaft sleeve
2	Gland
3	Packing ring
4	Lantern ring
A	Drilled hole for flushing liquid (pumped liquid)

Base

Pump and motor are mounted on a common base frame designed according to Hydraulic Institute standard, ANSI/HI 1.3-2000.

Painting

Prior to delivery to the customer, pump, motor and base are top coated with a blue paint (RAL 5015); coating thickness is 2 to 4 mils. The inside of the pump is primed for corrosion resistance. Standard units are not painted internally.

TM04 0478 0708

TM05 5784 3812

TM04 0472 0708

TM04 1849 1108

Test pressure

Pressure testing is made with water at ambient temperature. The standard hydrostatic test pressure is 1.5 times the flange rating pressure.

KP Case working pressure limitations at 150 °F: Flat-face flanges

Chart A

Cass material	Class 125 lb flange drilling (psi)		Class 250 lb flange drilling (psi)	
	CWP	Hydro	CWP	Hydro
Cast iron	175	265	250	375
Ductile iron	175	265	400	600

All sizes except as Chart B indicates

Chart B

Maximum case working pressure (class 125 Flange)						
Pump model number	6019	6020	8020	1020	1024	1220
Cast iron	175 psi					
Ductile iron	175 psi					
Maximum case working pressure (class 250 Flange)						
Pump model number	6019	6020	8020	1020	1024	1220
Cast iron	250 psi	250 psi	234 psi	222 psi	250 psi	211 psi
Ductile iron	375 psi	375 psi	351 psi	333 psi	375 psi	317 psi

CWP: maximum Case Working Pressure based upon flange drilling. Maximum working pressure for a given application is determined by adding the maximum available suction pressure to the shut-off head of a given impeller diameter.

Hydro: Is the hydrostatic test pressure applied to the pump. Minimum hydrostatic test pressure is 1.5 times maximum allowable case working pressure.

6. Operating conditions

Ambient temperature and altitude

The ambient temperature and the installation altitude are important factors for the motor life, as they affect the life of the bearings and the insulation system.

Ambient temperature must not exceed 104 °F [+ 40 °C]. If the ambient temperature exceeds 104 °F [+ 40 °C] or if the motor is installed more than 3280 ft [1000 m] above sea level, the motor must not be fully loaded due to the low density and consequently low cooling effect of the air. In such cases, it may be necessary to use a motor with a higher output, or use a motor that is designed for the specified ambient conditions.

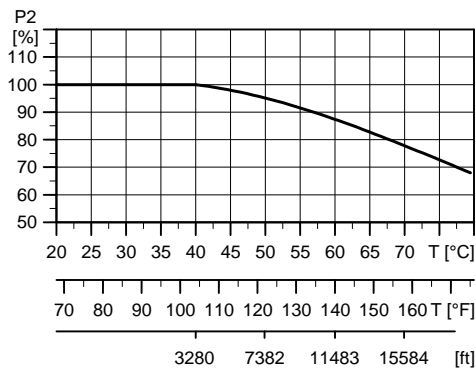

Fig. 19 Relationship between motor output (P2) and ambient temperature

TM00 2189 1598

Liquid temperatures and shaft seals

The maximum liquid temperature marked on the pump nameplate depends on the mechanical shaft seal used:

- Temperature range for Buna - standard): 32 °F to 212 °F [0 °C to +100 °C].
- Temperature range for Viton 54 °F to 212 °F [+15 °C to +100 °C].
- Temperature range for EPDM 54 °F to 275 °F [+15 °C to +135 °C].

Shaft seal

The materials of the shaft seal types used in KP pumps have certain characteristics. These characteristics may be of importance when choosing the shaft seal for the pump.

Carbon/Ceramic

The seal has the following features:

- Brittle material requiring careful handling.
- Worn by liquids containing solid particles.
- Limited corrosion resistance, $5 < \text{pH} < 9$, depending on ceramic type.
- The carbon of the seal offers properties very similar to the carbon/tungsten carbide seal. However, compared to the carbon/tungsten carbide seal, the pressure and temperature ranges are limited.

Carbon/silicon carbide

Seals with one carbon seal face have the following features:

- Brittle material requiring careful handling
- Worn by liquids containing solid particles
- Good corrosion resistance
- The self-lubricating properties of carbon make the seal suitable for use even with poor lubricating conditions (high temperatures) without generating noise. However, such conditions will cause wear of the carbon seal face leading to reduced seal life.

Buna

NBR (nitrile) rubber covers a wide range of liquids at temperatures below 212 °F [+100 °C].

- Good mechanical properties
- Standard material

Viton

FKM rubber covers a very wide range of liquids and temperatures.

- Poor mechanical properties at low temperatures
- Resistant to water up to 275 °F [+135 °C]
- Resistant to mineral oils and vegetable oils
- Not resistant to alkaline liquids at high temperatures.

EPDM

EPDM Rubber covers a wider range of liquids up to a max temperature of 275 °F [135 °C].

- Good mechanical properties.

Pressure

Maximum inlet pressure

Inlet pressure + pump pressure must always be lower than maximum pressure of the pump.

Minimum inlet pressure

The minimum inlet pressure must correspond to the NPSH curve for the pump.

Flow

Minimum flow rate

The pump must not run against a closed discharge valve, as this will cause an increase in temperature/formation of steam in the pump. This may cause shaft damage, impeller erosion, short life of bearings, stuffing boxes with packing rings or mechanical seals due to stress or vibration.

The minimum, continuous flow rate must be at least 25% of the flow rate at best-efficiency point (BEP).

KP Impeller Max Sphere Size

Split Case Model	Max Sphere Size [inches]
2095-1/2	0.19
2013-5/6	0.16
3095-7/8	0.31
3014-7/8	0.31
4012-1/2	0.38
4012-7/8	0.75
4015-9/0	0.25
5012-7/8	0.63
5015-9/0	0.75
6012-3/4	1.00
6015-3/4	0.81
6019-7/8	0.75
6020-3/4	0.75
8012-5/6	0.88
8015-3/4	1.00
8020-5/6	1.03
1012-1/2	1.00
1015-3/4	1.25
1020-3/4	1.20
1024-3/4	1.17
1220-5/6	1.87
1415-1/2	1.25

7. Curve charts and technical data

How to read the curve charts

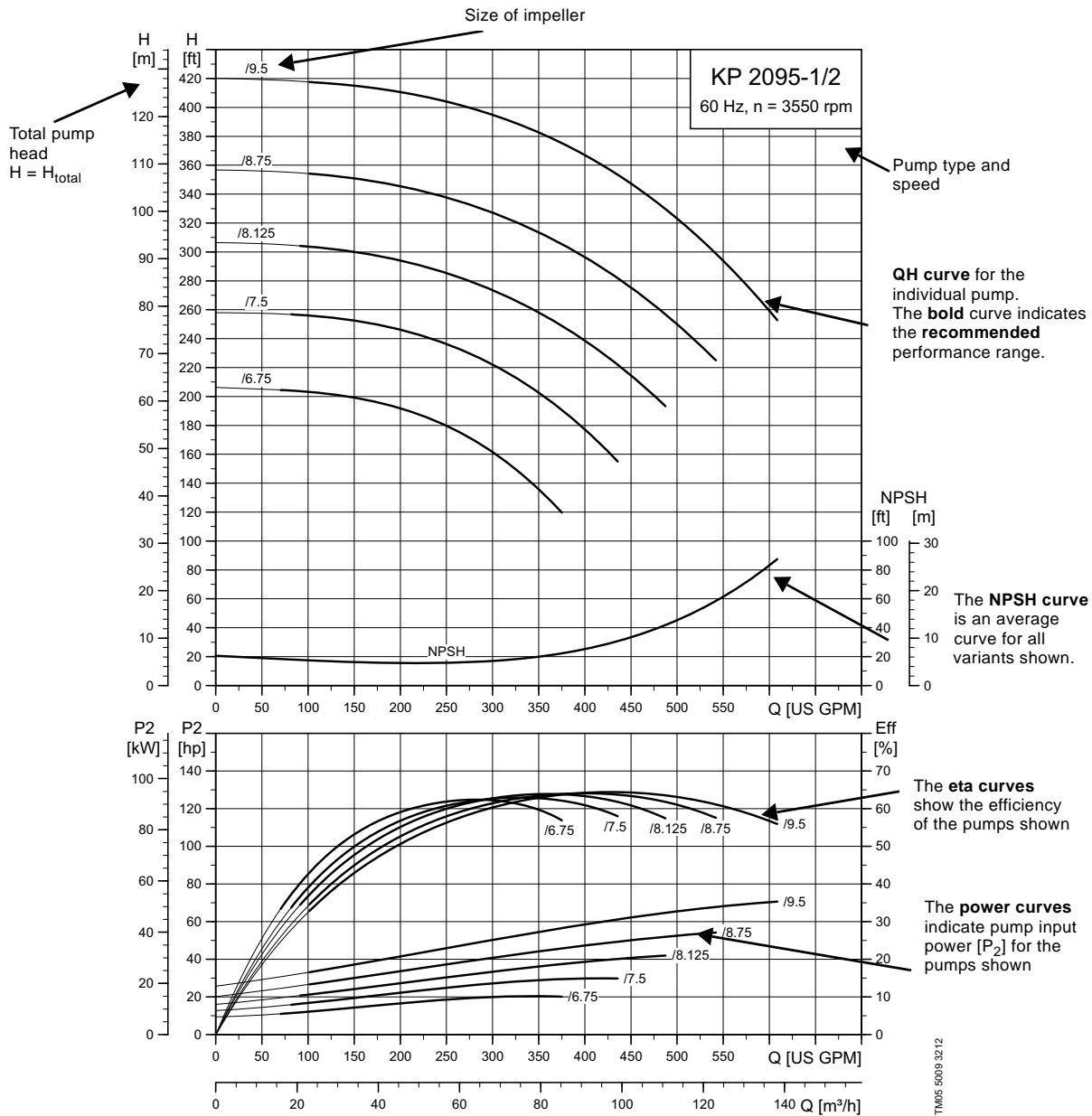

Reference the Express Suite selection tool for selections in additional speeds.

Curve conditions

The guidelines below apply to the curves shown in the performance charts.

- Tolerances according to: Hydraulic Institute.
- The curves show pump performance with different impeller diameters at the nominal speed.
- The **bold** part of the curves show the **recommended** operating range.
- Do not operate the pump along the thin parts of the curves. If your duty point lies here, you should select a smaller or larger pump type.
- Do not use the pumps at minimum flows below $0.1 \times Q_{\max}$ stated on the pump name plate because of the risk of overheating of the pump.
- The curves apply to the pumping of airless water at a temperature of 77 °F [$+20\text{ °C}$] and a kinematic viscosity of 1 cSt [$1\text{ mm}^2/\text{s}$].
- **ETA:** The lines show values of the hydraulic efficiency of the pump for the different impeller diameters.
- **NPSH:** The curves show average values measured under the same conditions as the performance curves.
When sizing the pump, add a safety margin of at least 1.6 ft [0.5 m].
- In case of other densities than 62.3 lb/ft^3 [1000 kg/m^3] the discharge pressure is proportional to the density.
- When pumping liquids with a specific gravity higher than 1.0 , motors with correspondingly higher outputs must be used.

Calculation of total head

The total pump head consists of the height difference between the measuring points + the differential head + the dynamic head.

$$H_{\text{total}} = H_{\text{geo}} + H_{\text{stat}} + H_{\text{dyn}}$$

H_{geo} :	Height difference between measuring points.
H_{stat} :	Differential head between suction and the discharge side of the pump.
H_{dyn} :	Calculated values based on the velocity of the pumped liquid on the suction and the discharge side of the pump.

Performance tests

Requested tests are performed according to Hydraulic Institute. Performance tests are only completed when ordered with the pump.

Witness test

When the pumps are being tested it is possible for the customer to witness the testing procedure according to Hydraulic Institute.

If the customer wants to witness the pump test this request must be submitted with the order.

KP 2095-1/2 [2-pole]

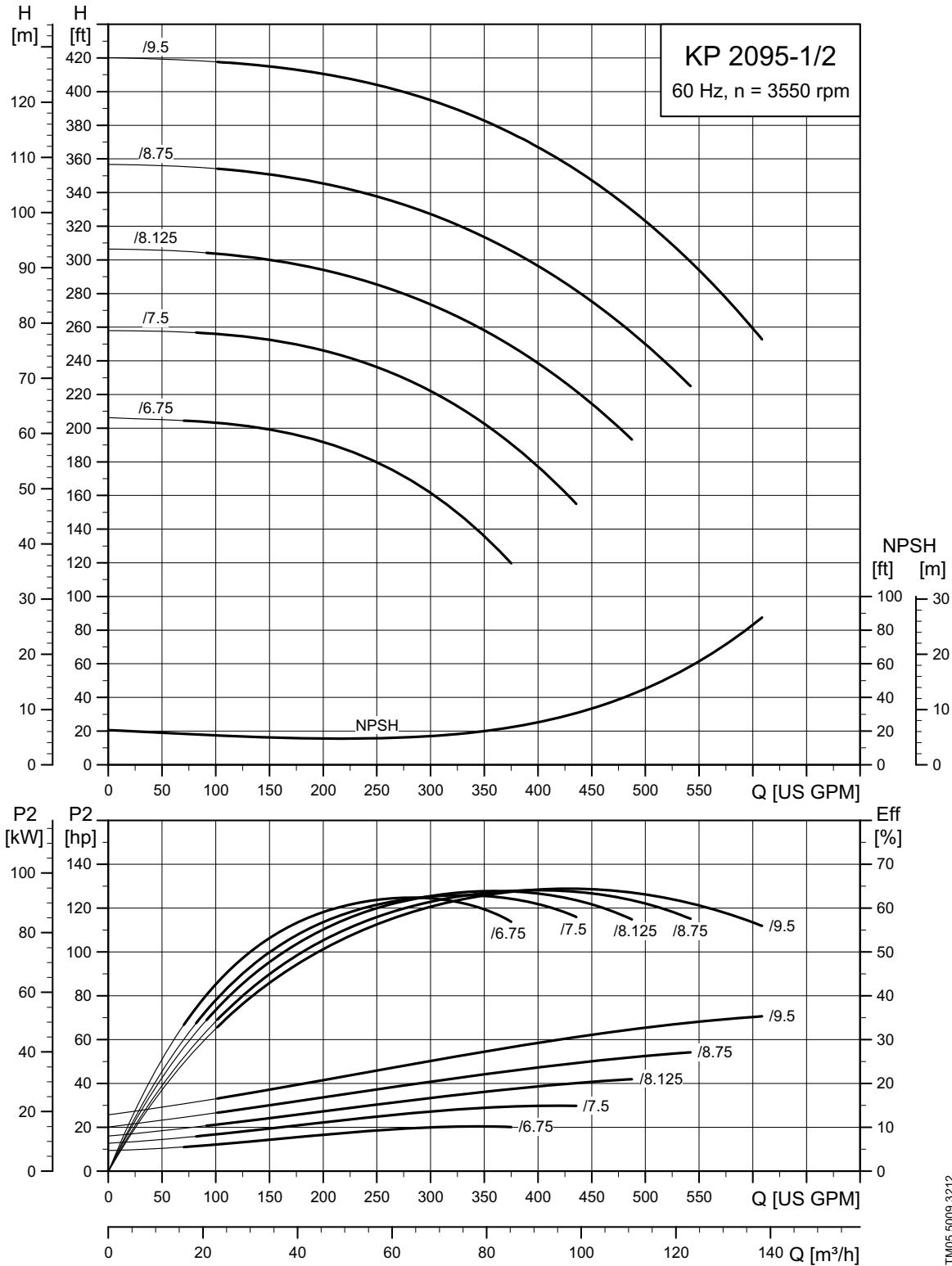

TM05 5009 3212

KP 3095-7/8 [2-pole]

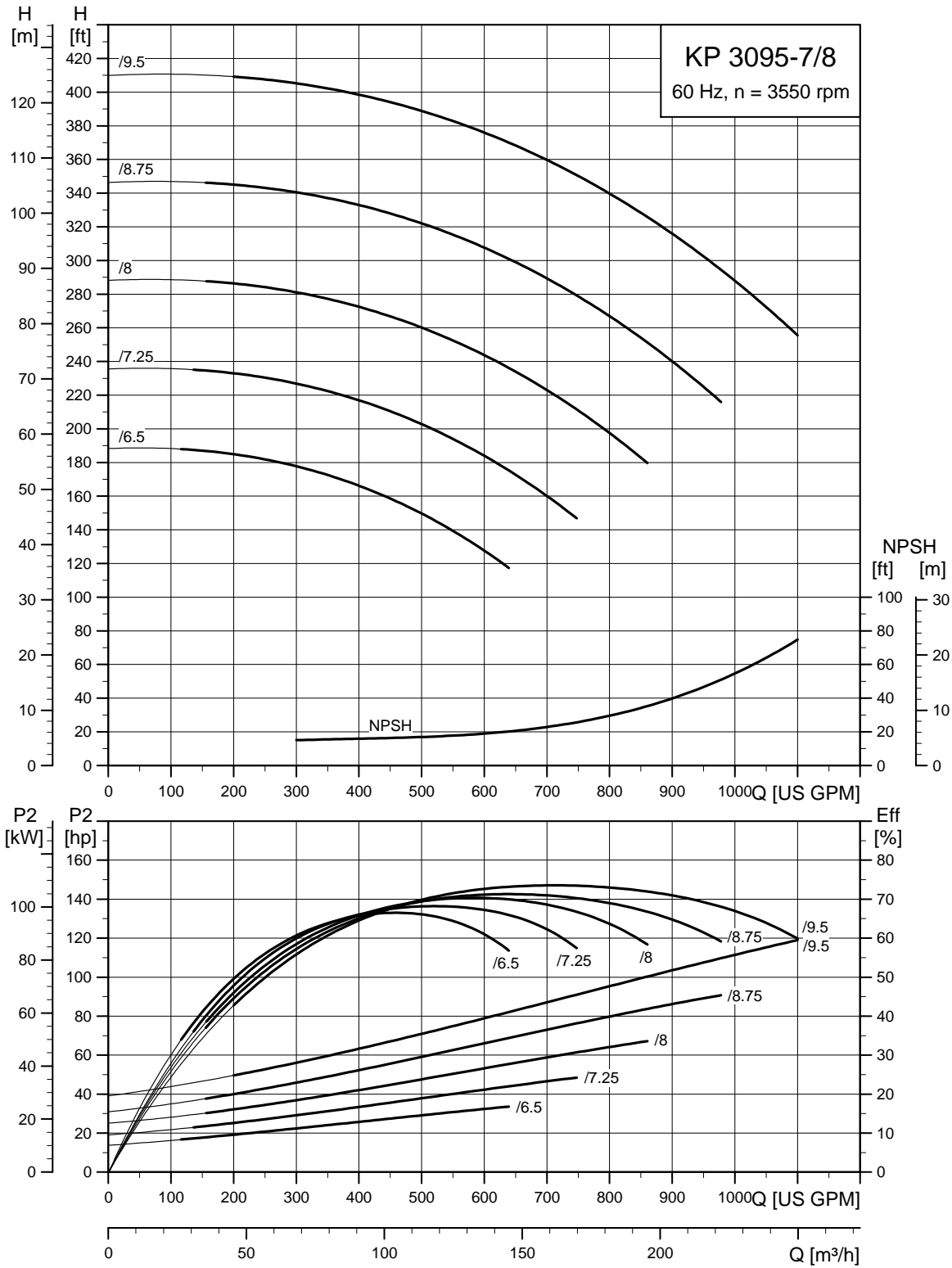

TM05 5010 3212

KP 4012-1/2 [2-pole]

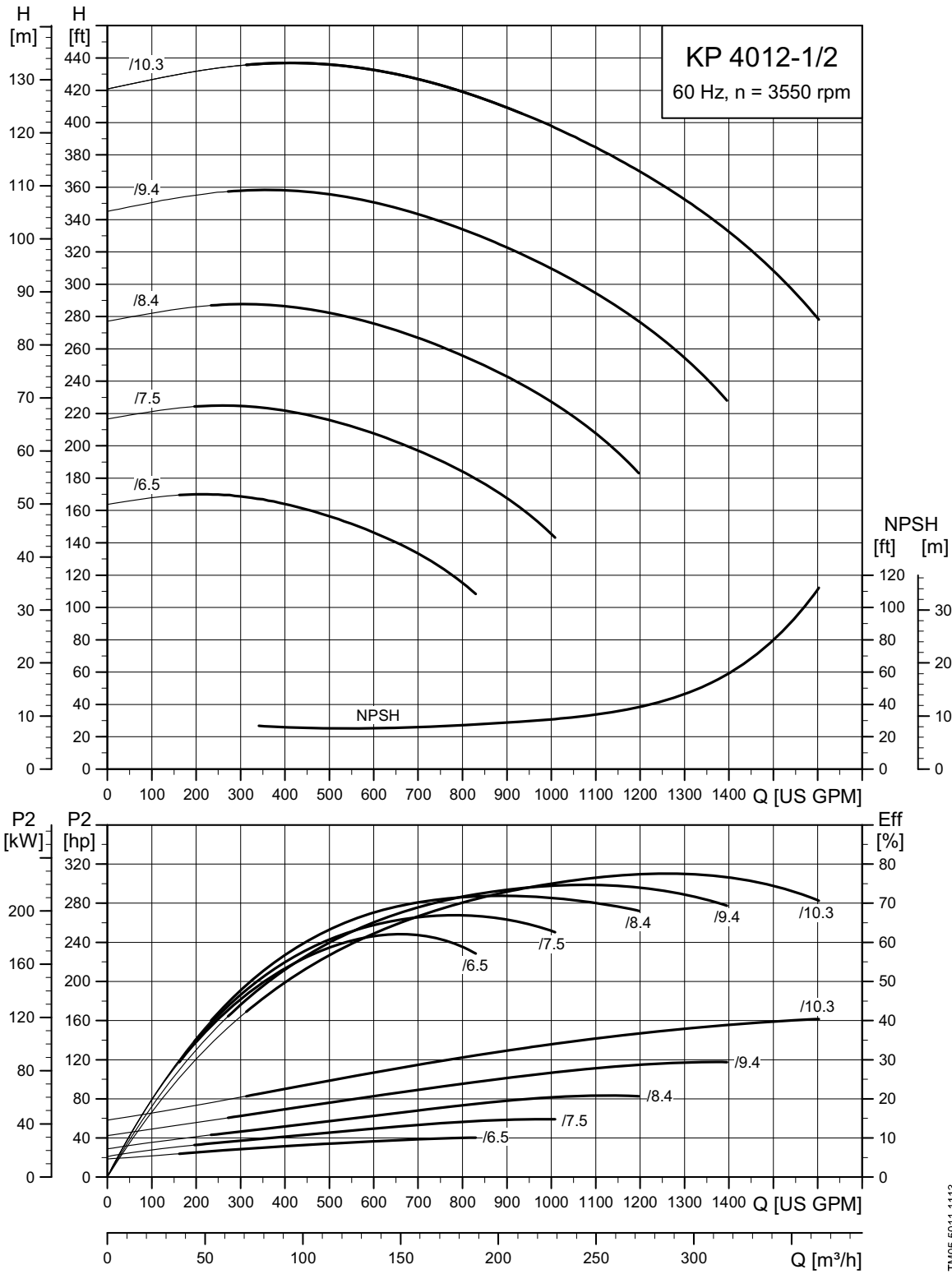

TM05 5011 1113

KP 4012-7/8 [2-pole]

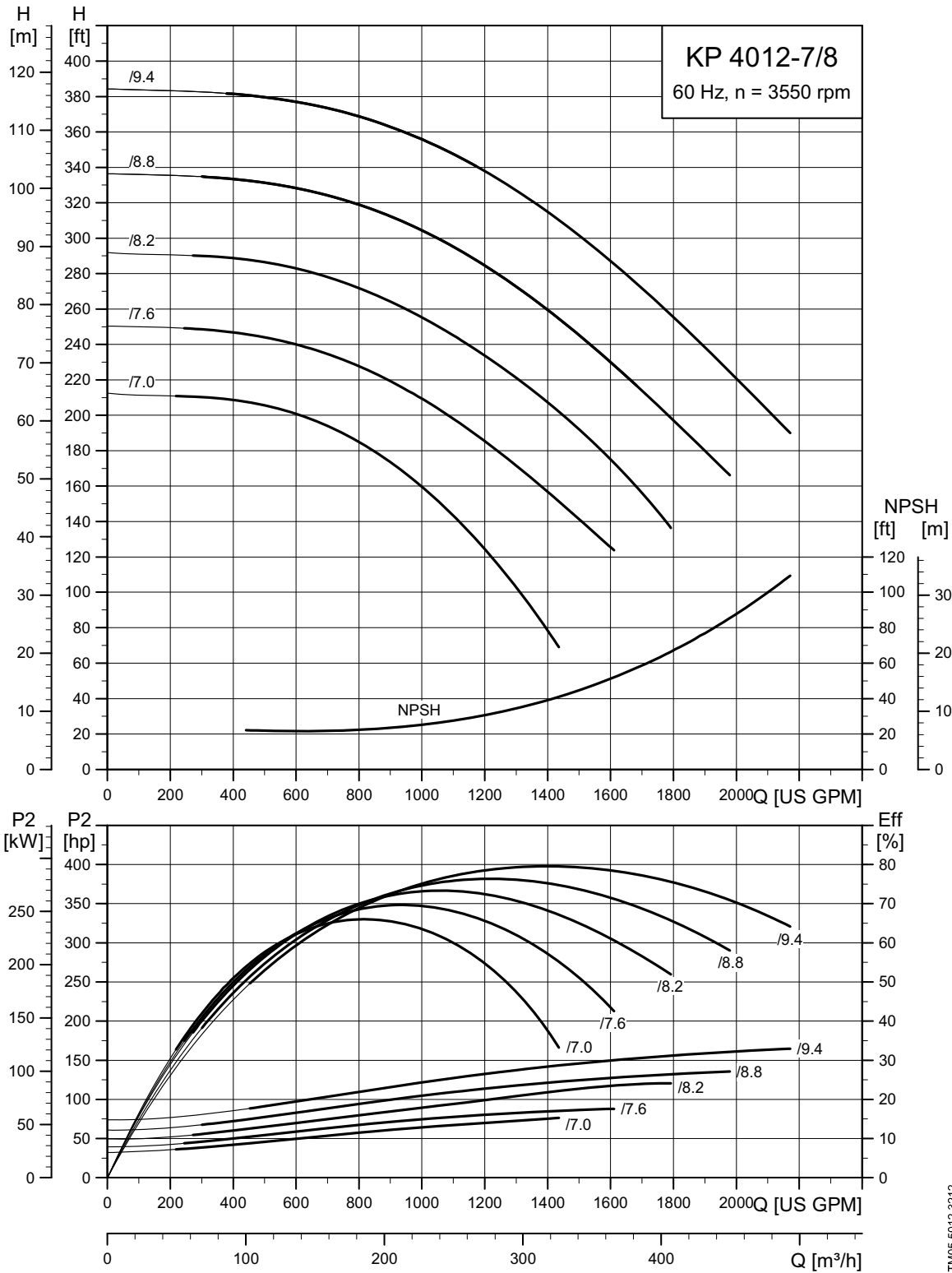

TM05 5012 3212

KP 2095-1/2 [4-pole]

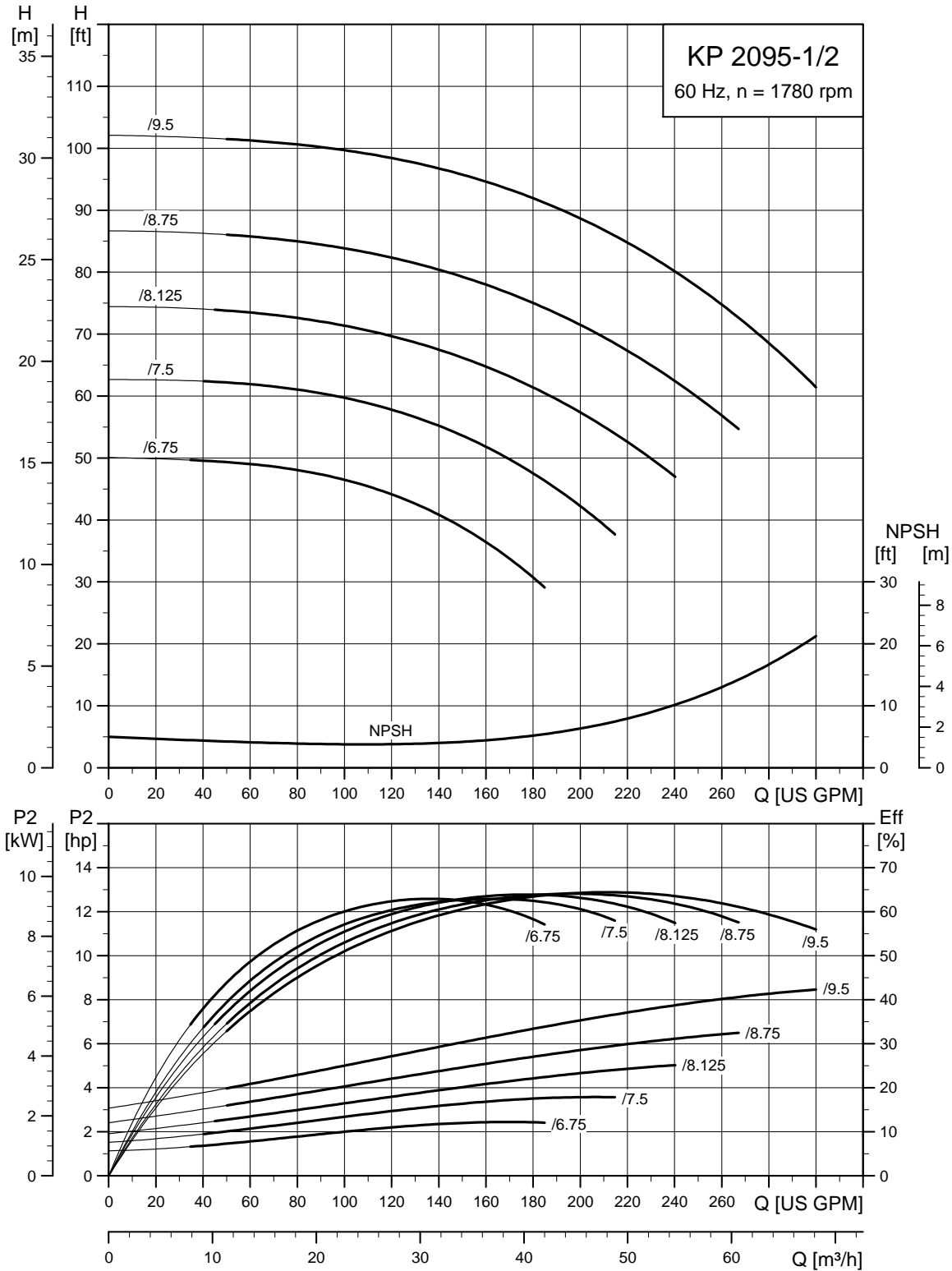

TM05 5013 3912

KP 2013-5/6 [4-pole]

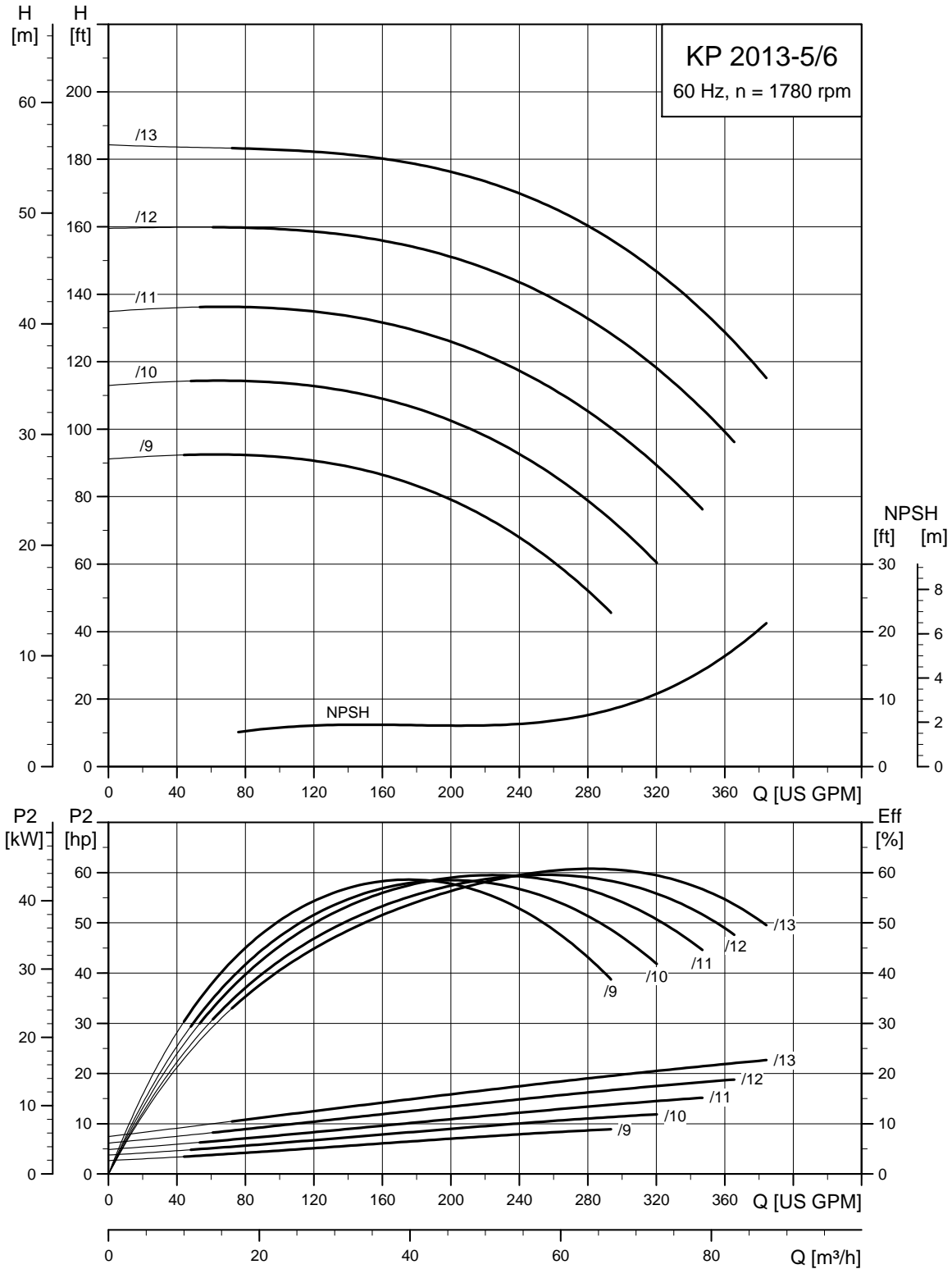

TM05 5014 3912

KP 3095-7/8 [4-pole]

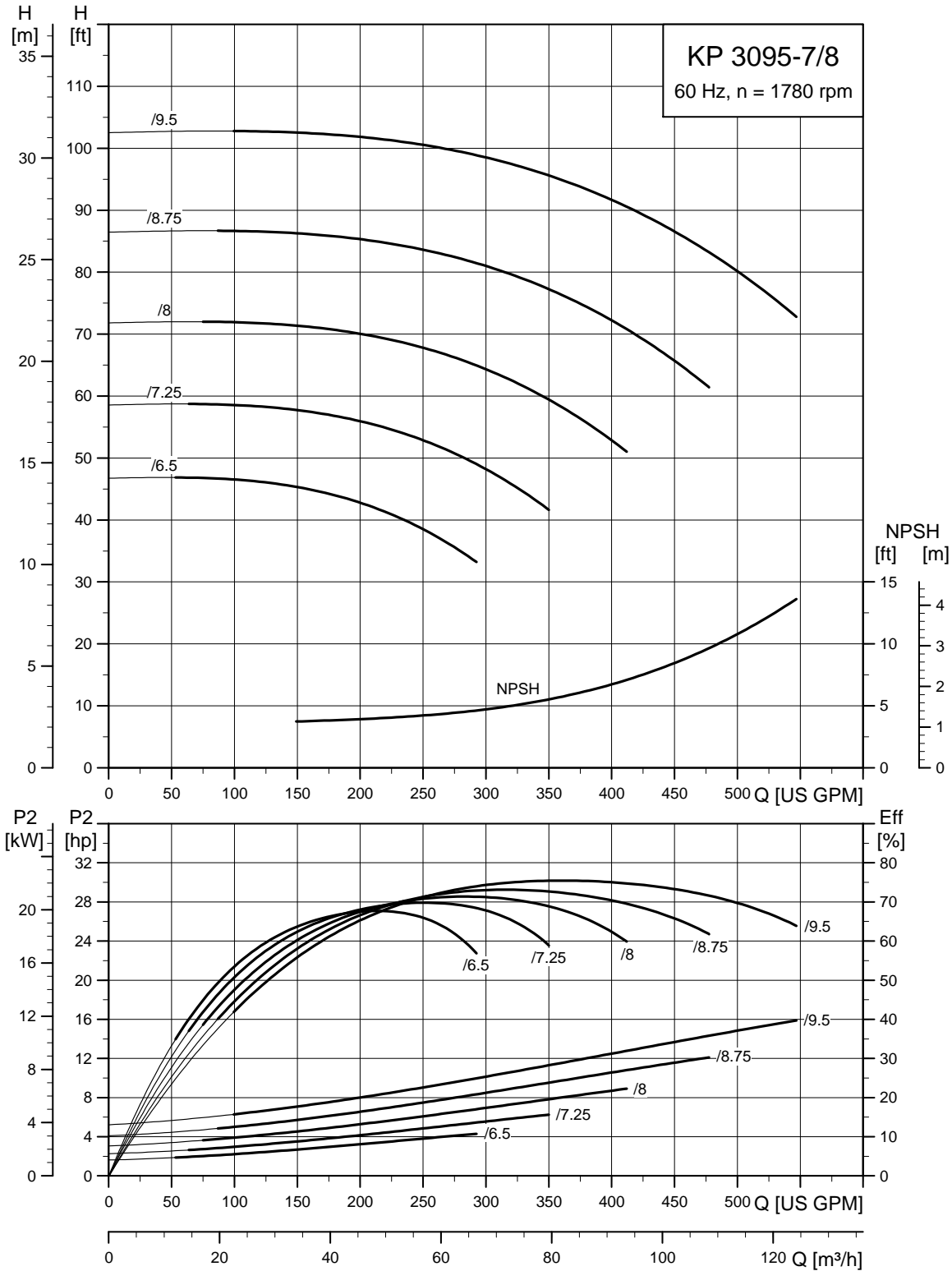

TM05 5015 3912

KP 3014-7/8 [4-pole]

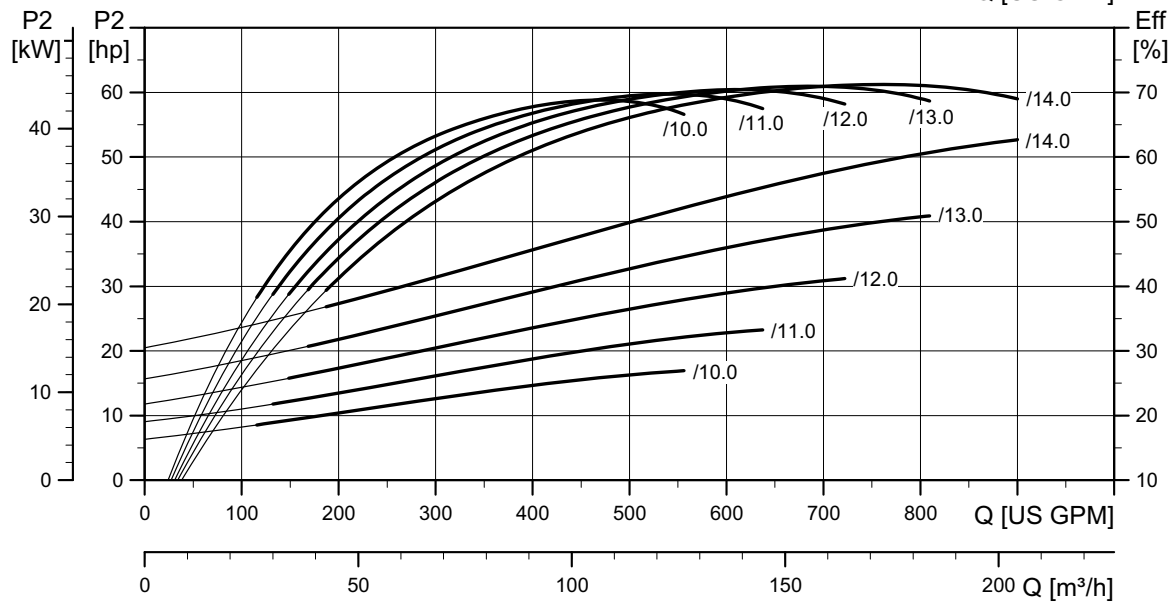
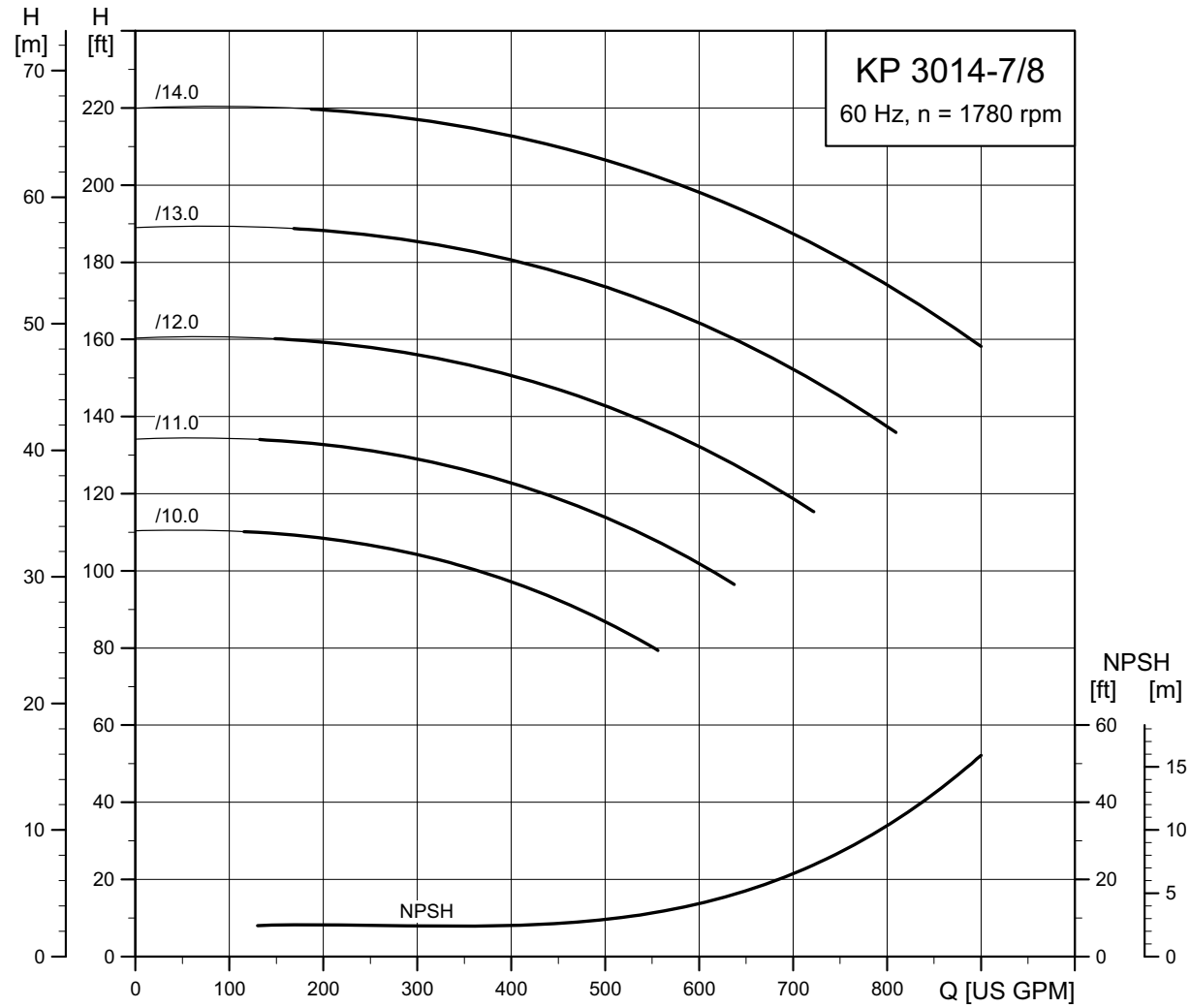

TM05 5016 3212

TM05 5016 3912

KP 4012-1/2 [4-pole]

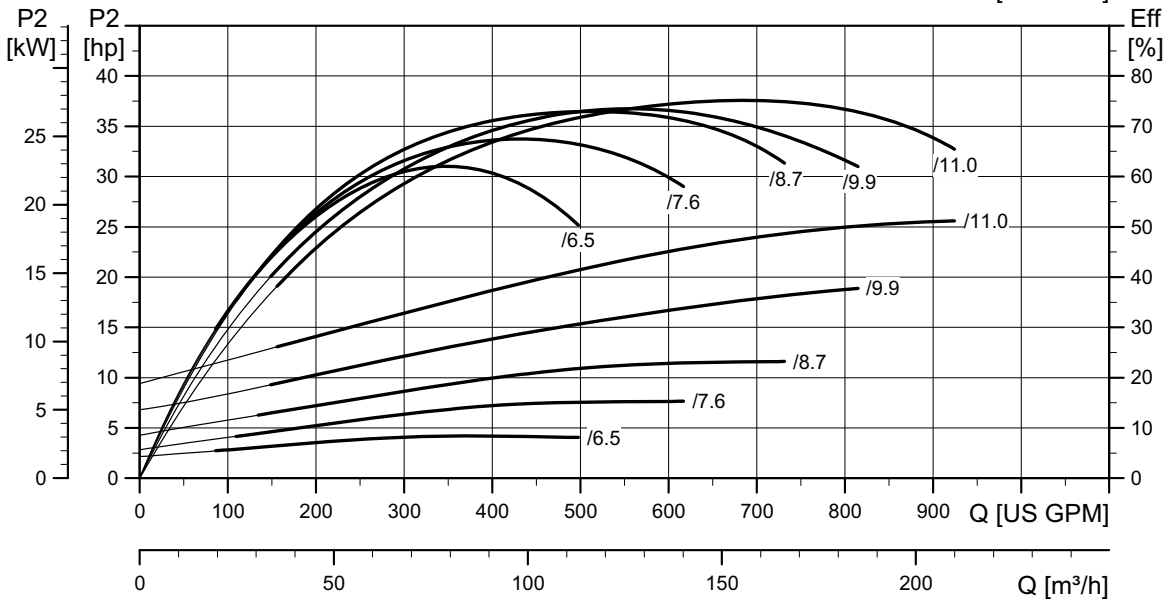
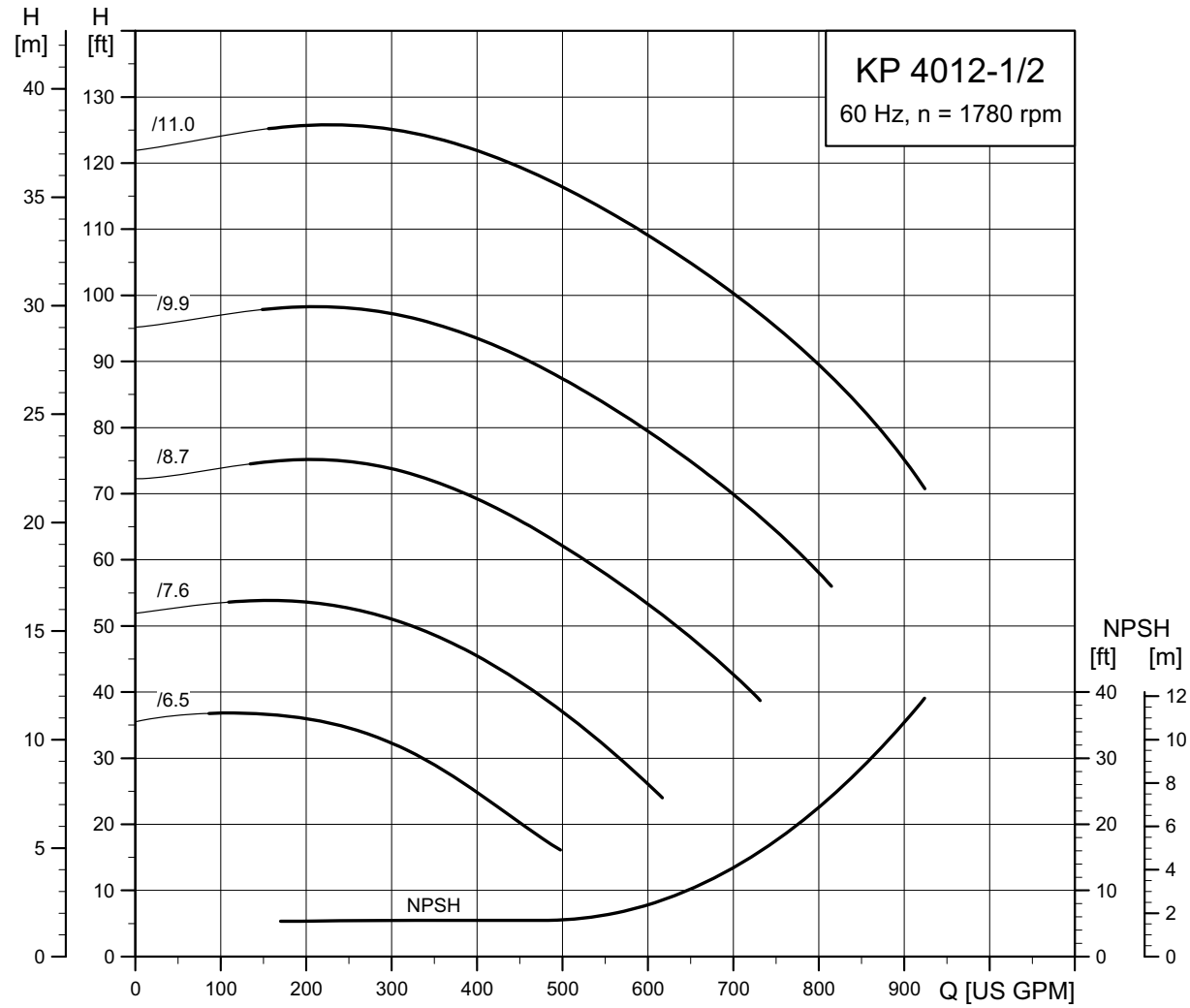

TM05 5017 3212

TM05 5017 3912

KP 4012-7/8 [4-pole]

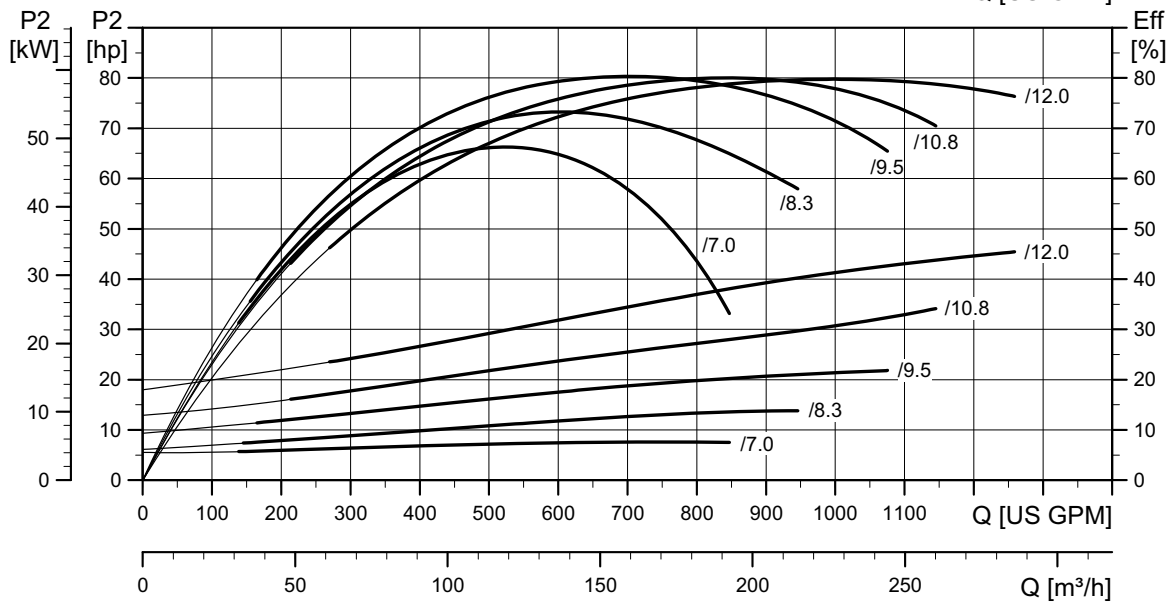
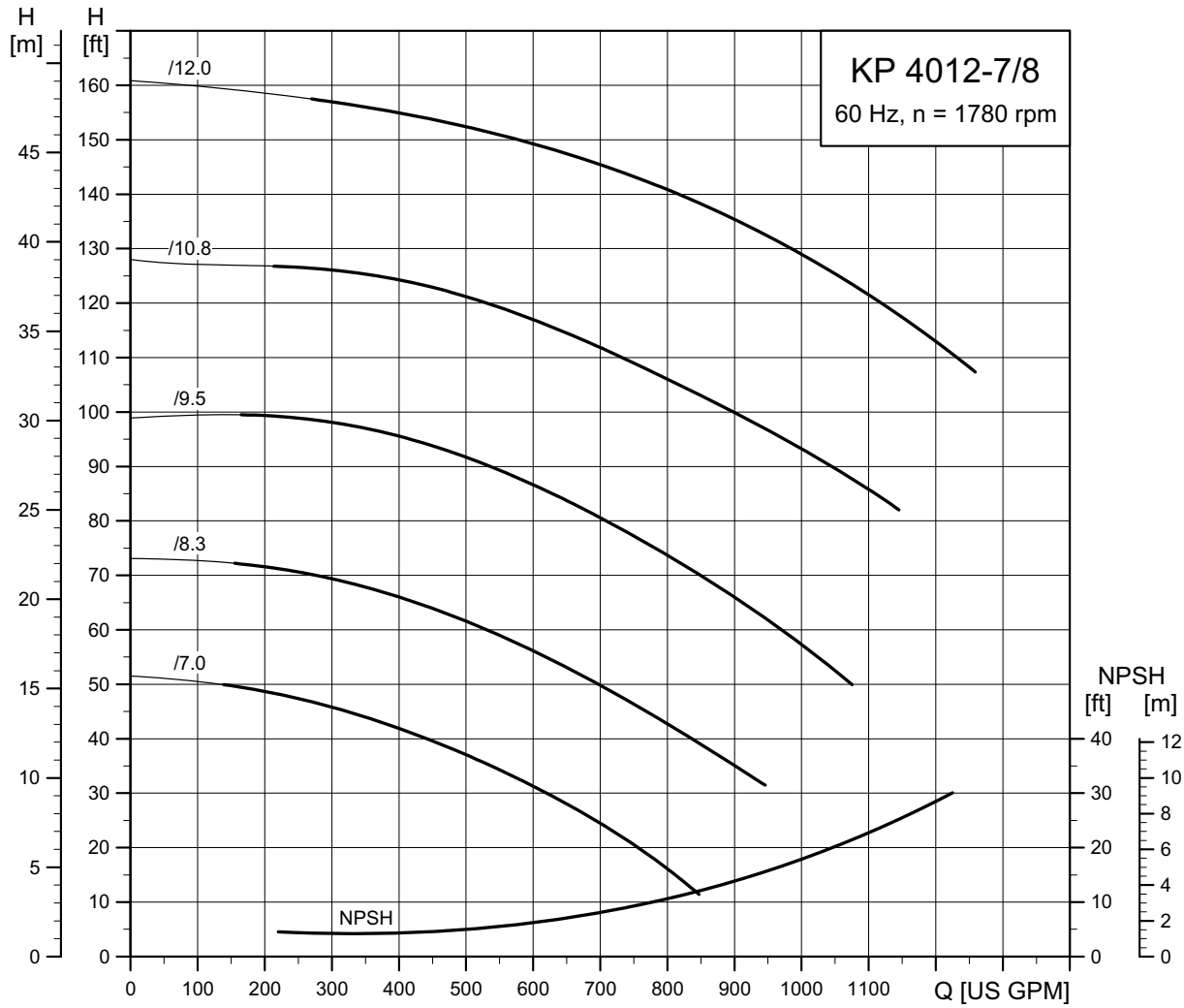

TM05 5018 3212

TM05 5018 3912

KP 4015-9/0 [4-pole]

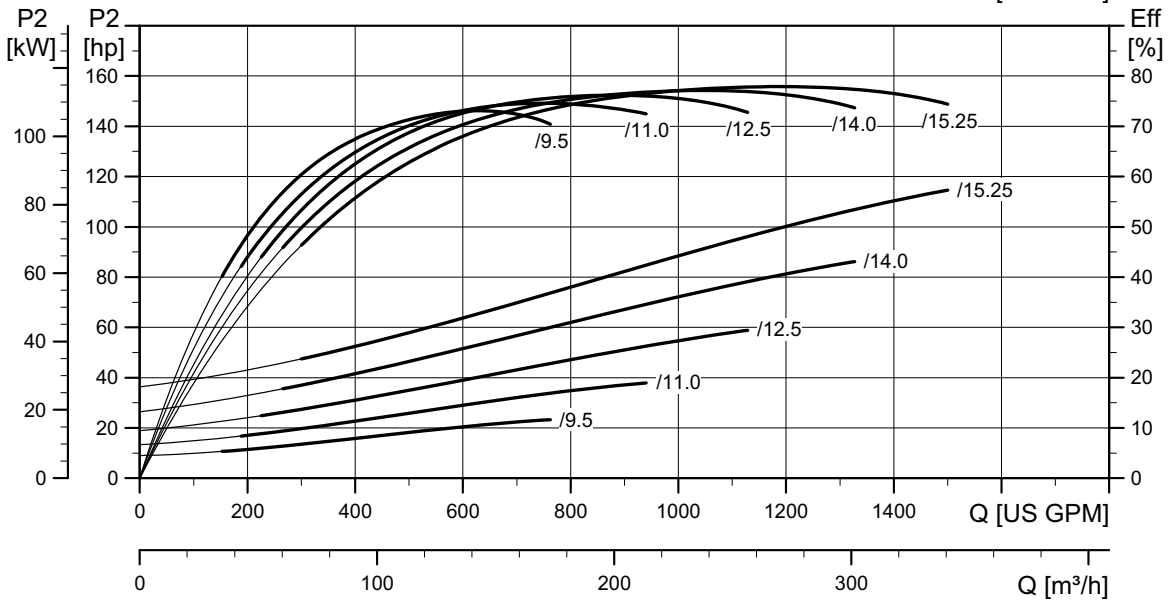
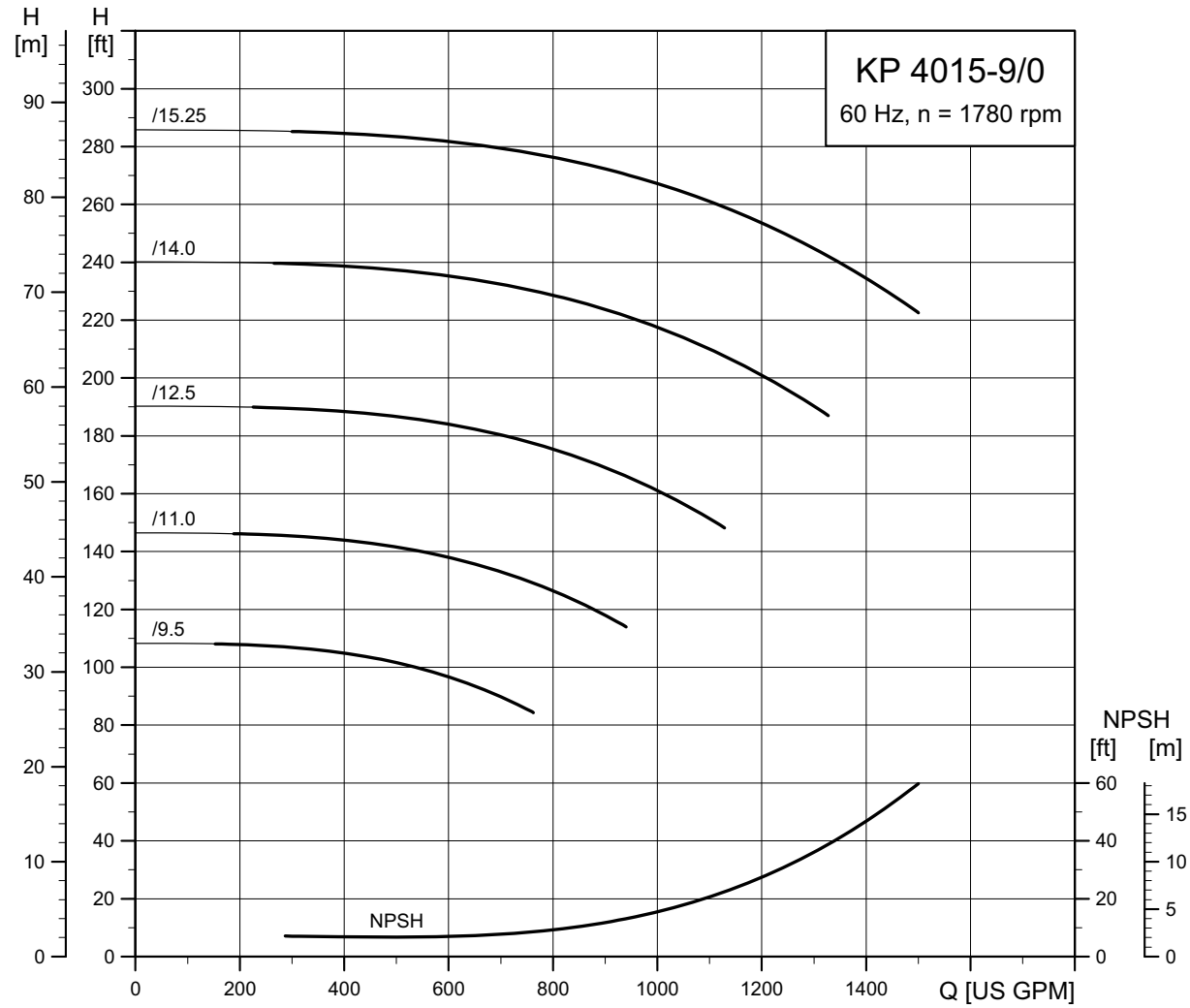

TM05 5019 3212

TM05 5019 3912

KP 5012-7/8 [4-pole]

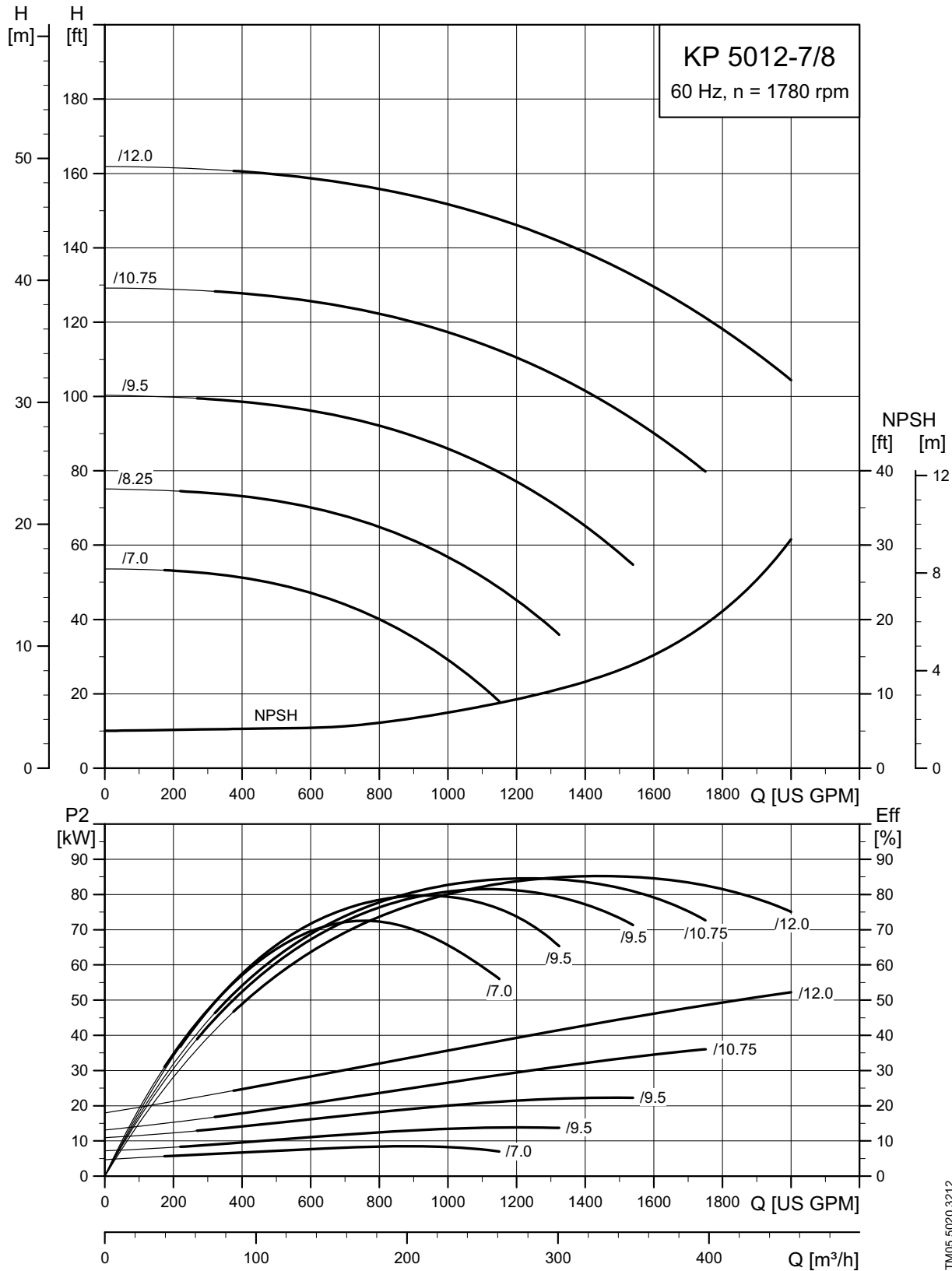

TM05 5020 3212

TM05 5020 3912

KP 5015-9/0 [4-pole]

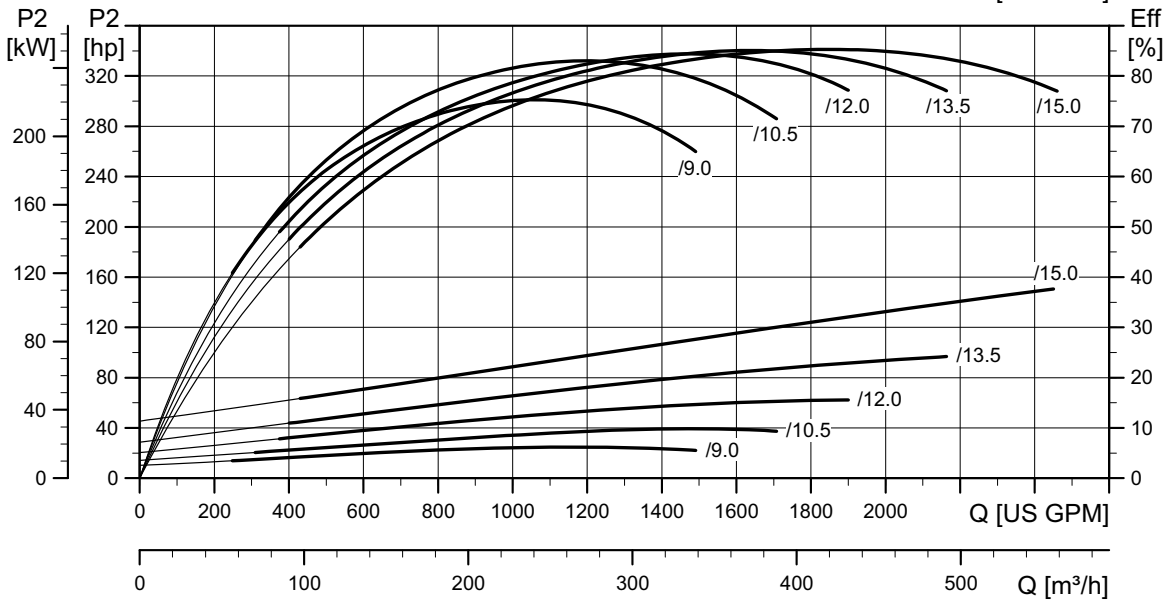
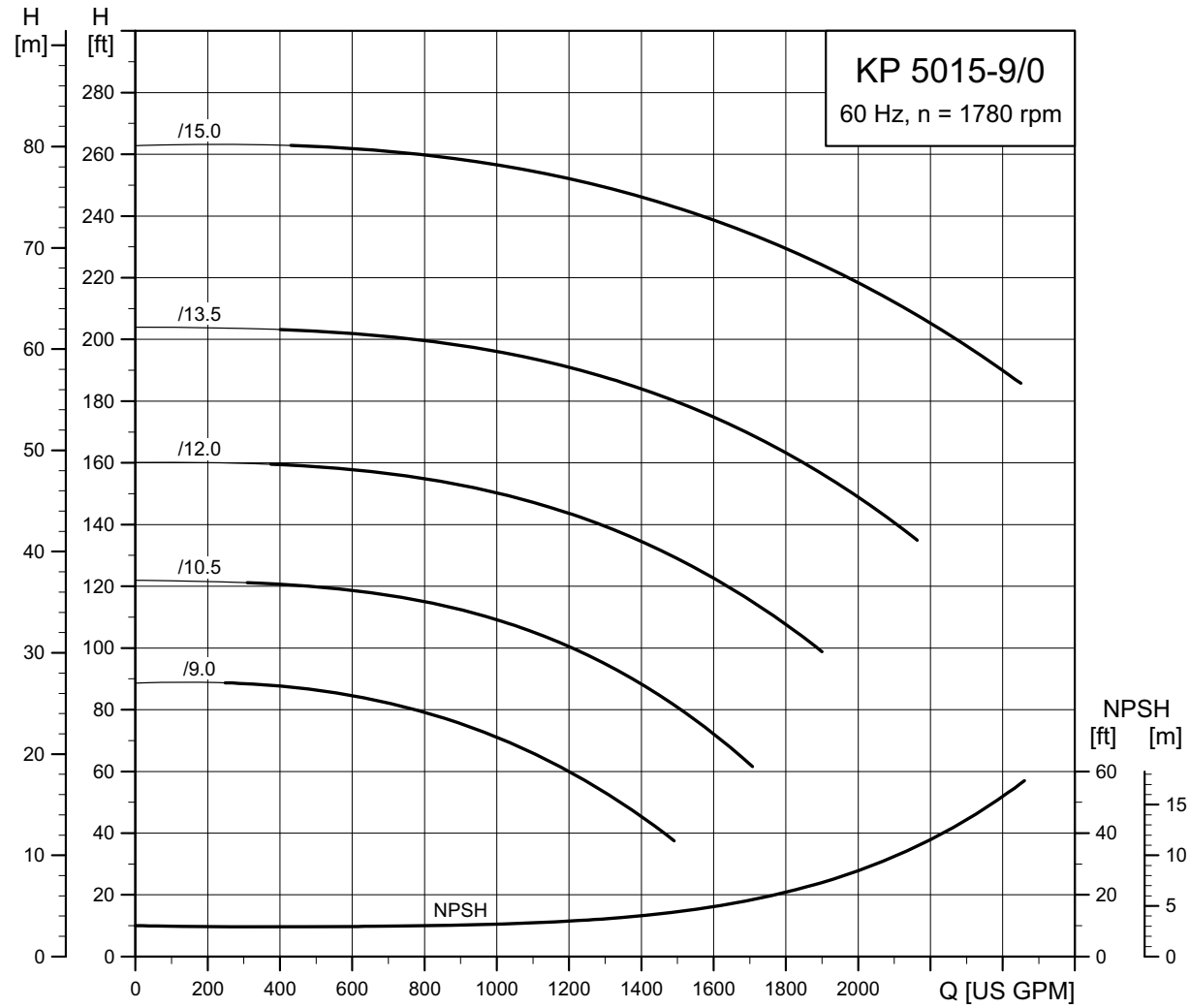

TM05 5021 3212

TM05 5021 3912

KP 6012-3/4 [4-pole]

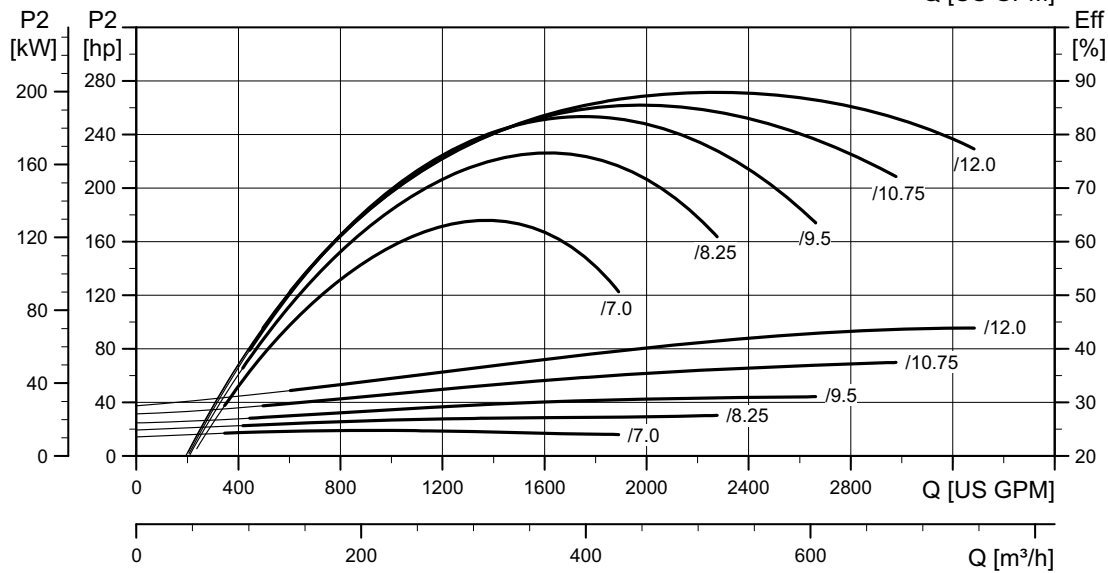
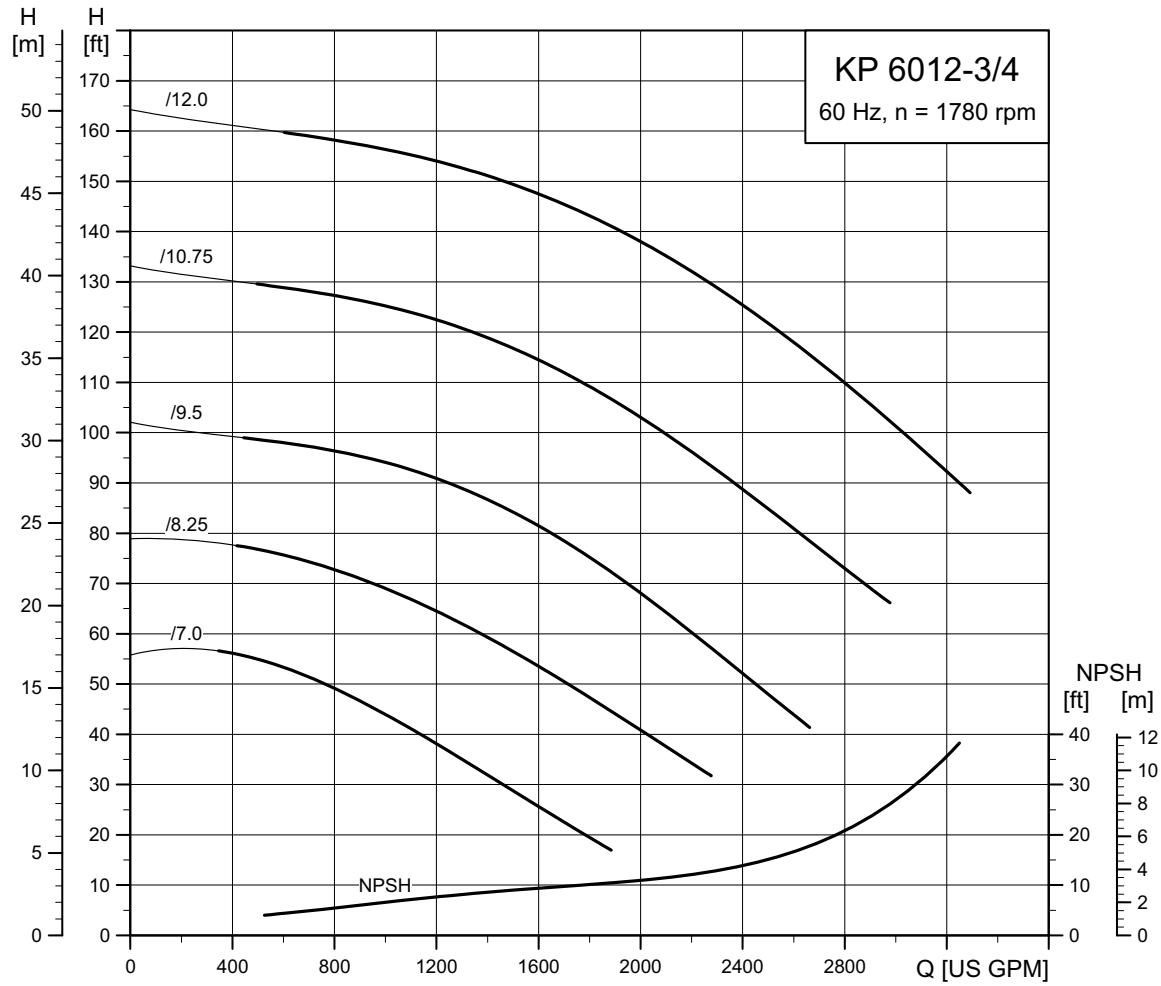

TM05 5023 3212

KP 6015-3/4 [4-pole]

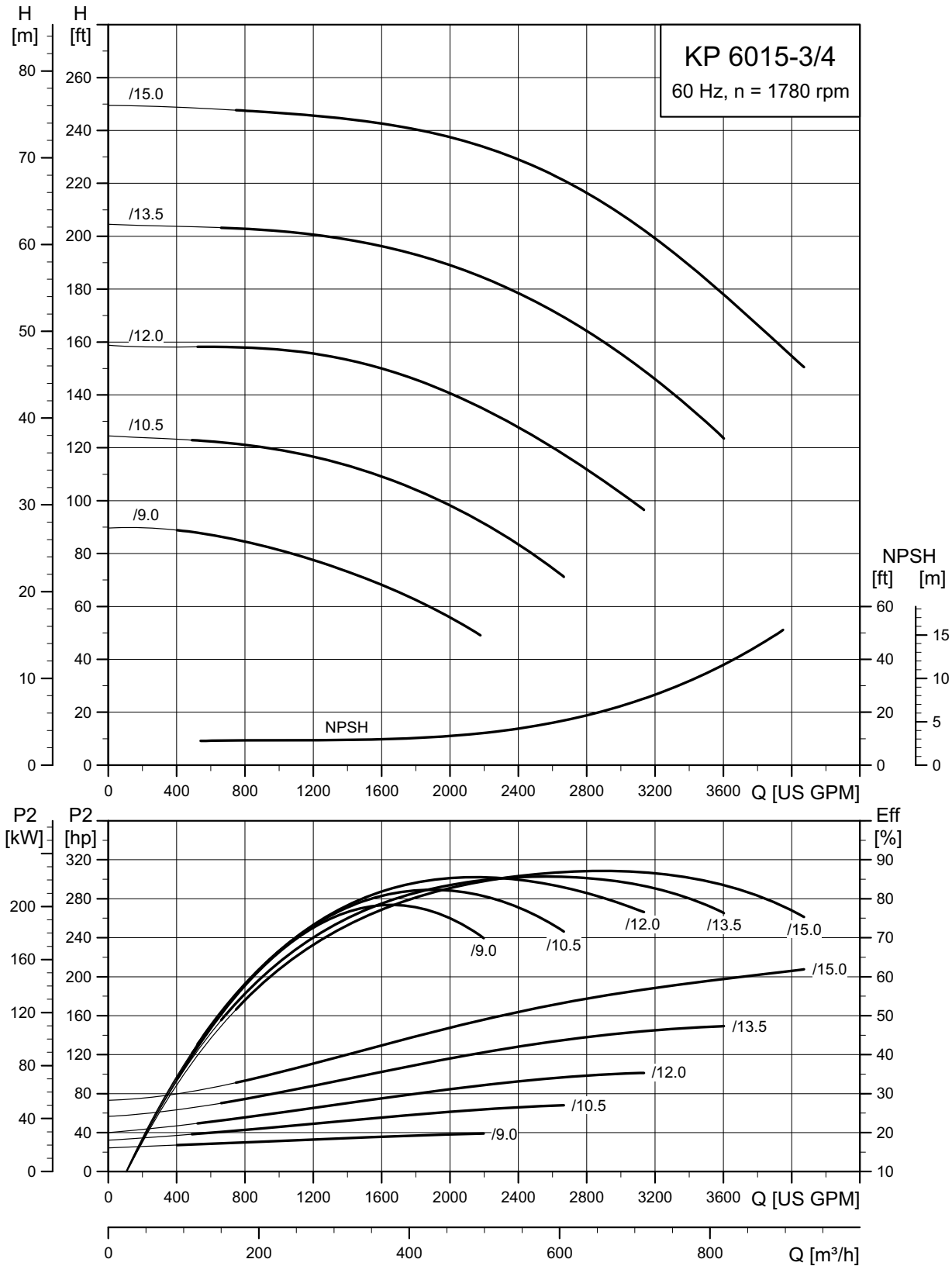

TM05 5024 3912

KP 6019-7/8 [4-pole]

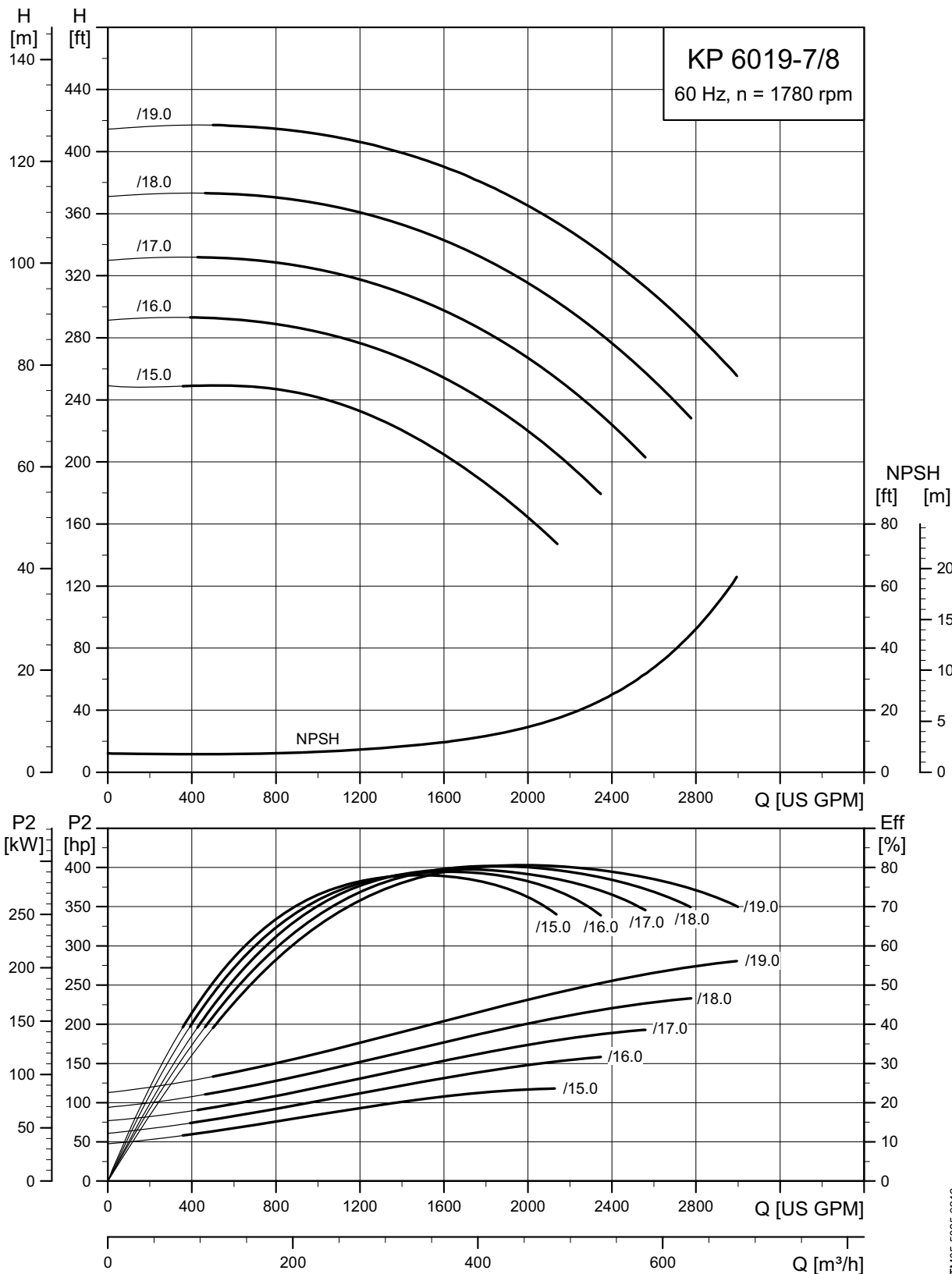

TM05 5025 3212

KP 6020-3/4 [4-pole]

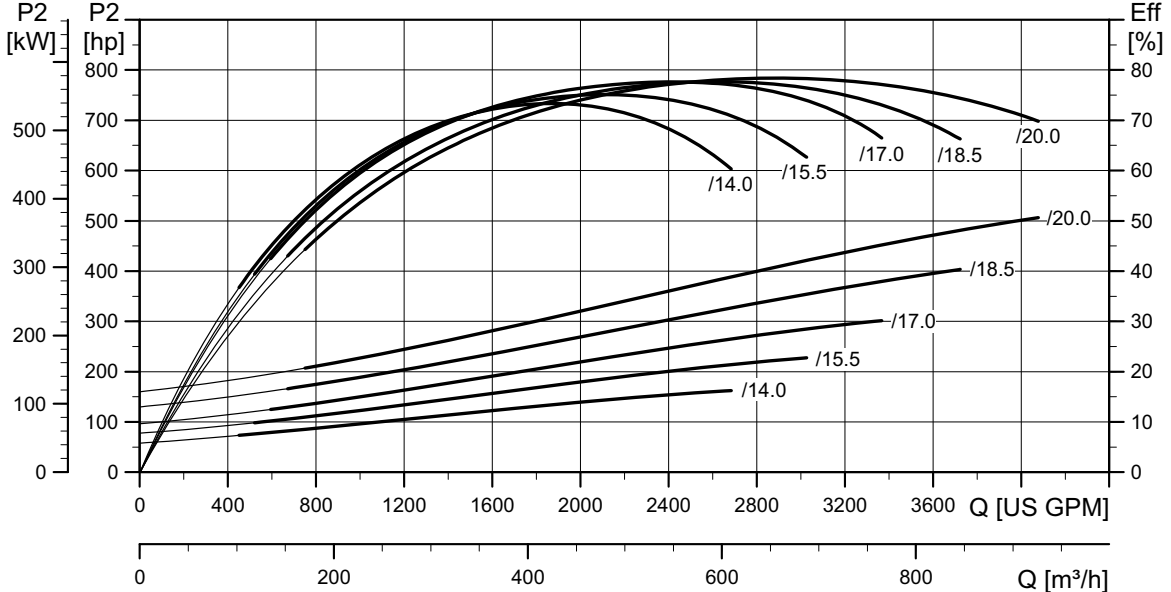
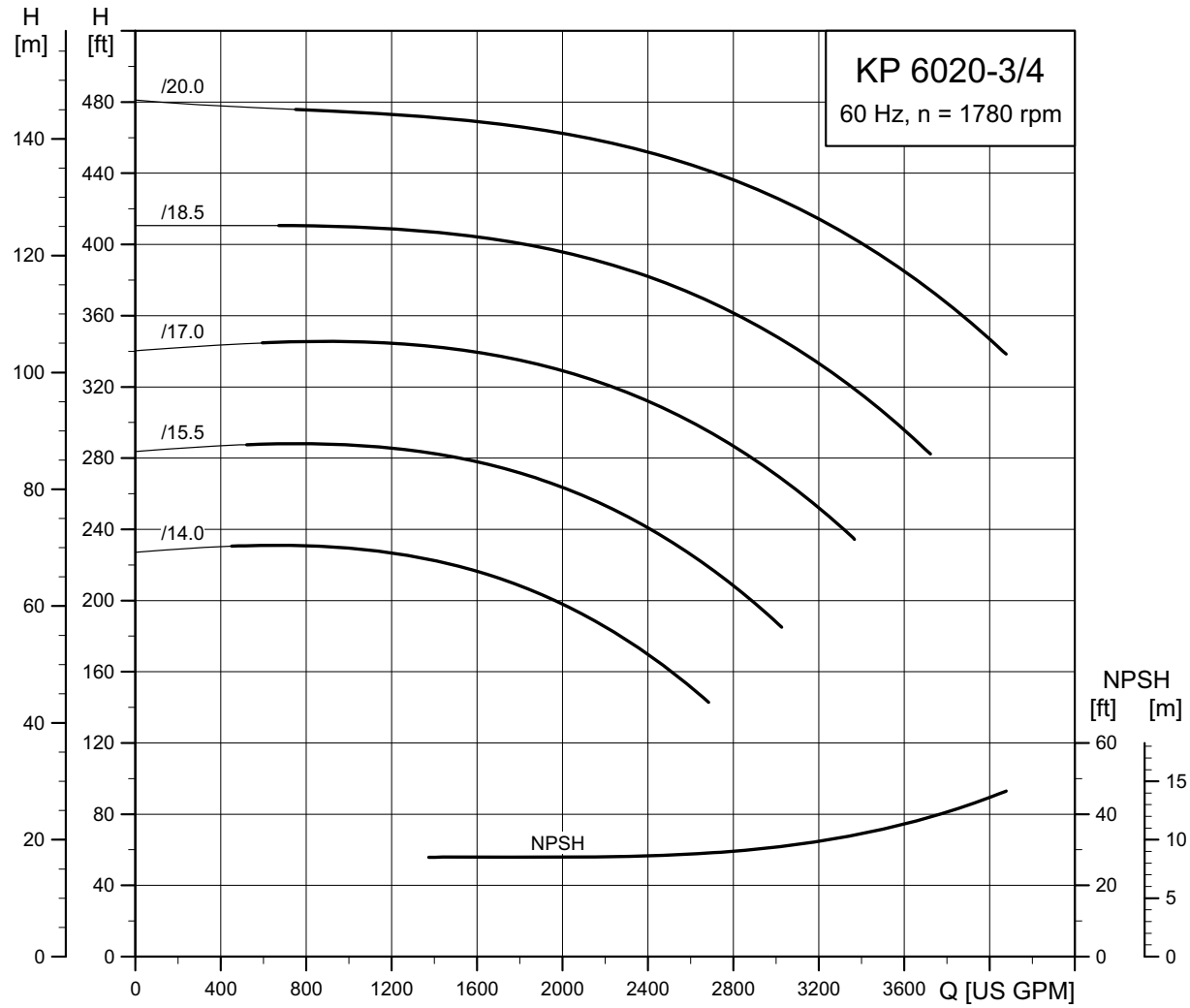

TM05 5026 3212

TM05 5026 3912

KP 8012-5/6 [4-pole]

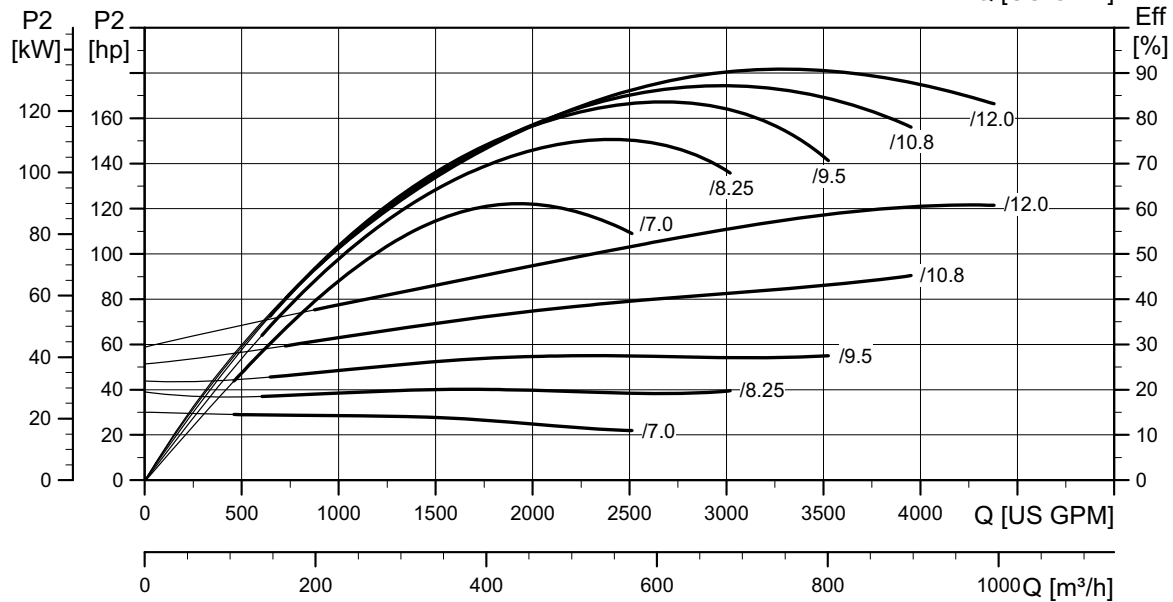
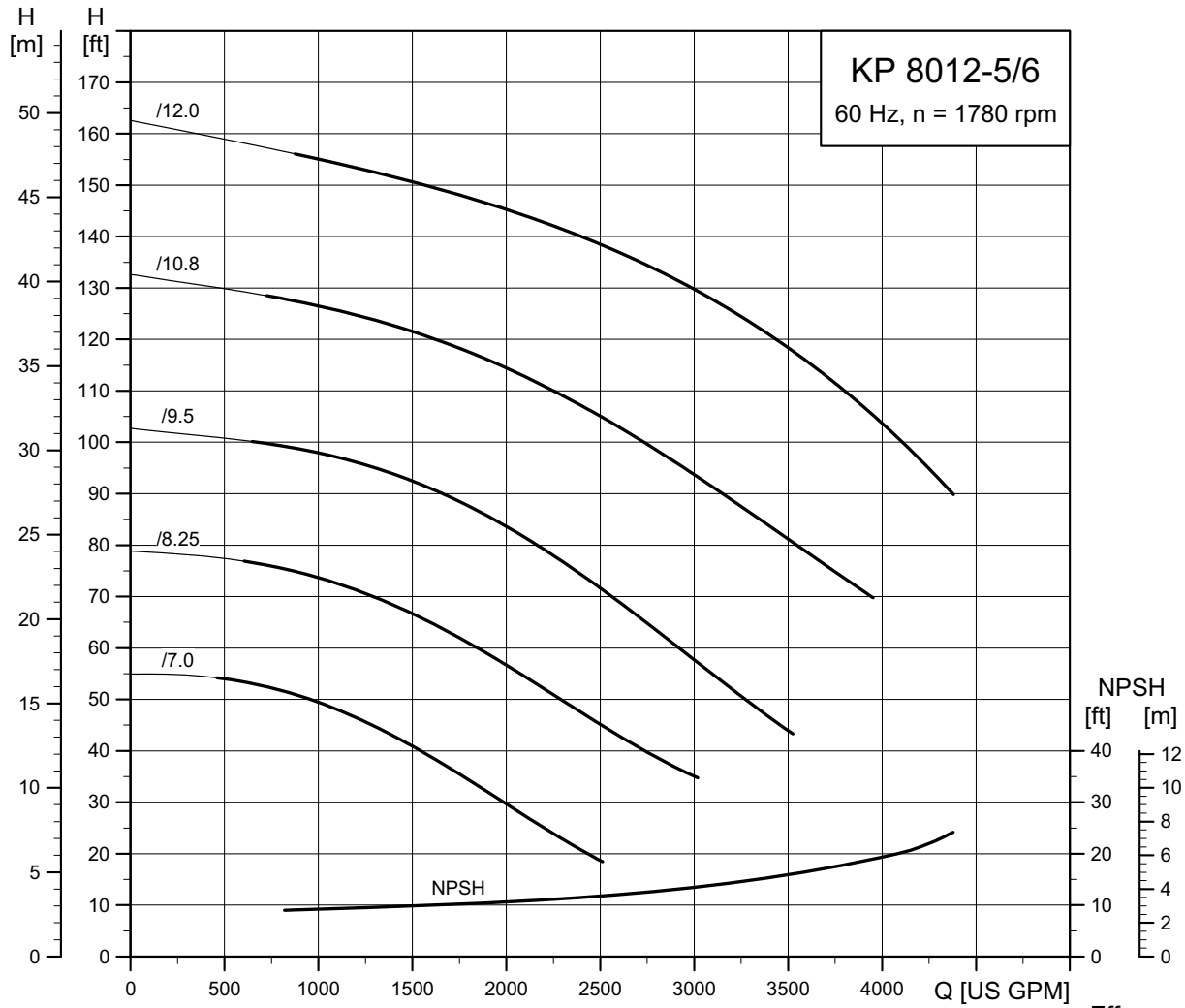

TM05 5027 3212

TM05 5027 3912

KP 8015-3/4 [4-pole]

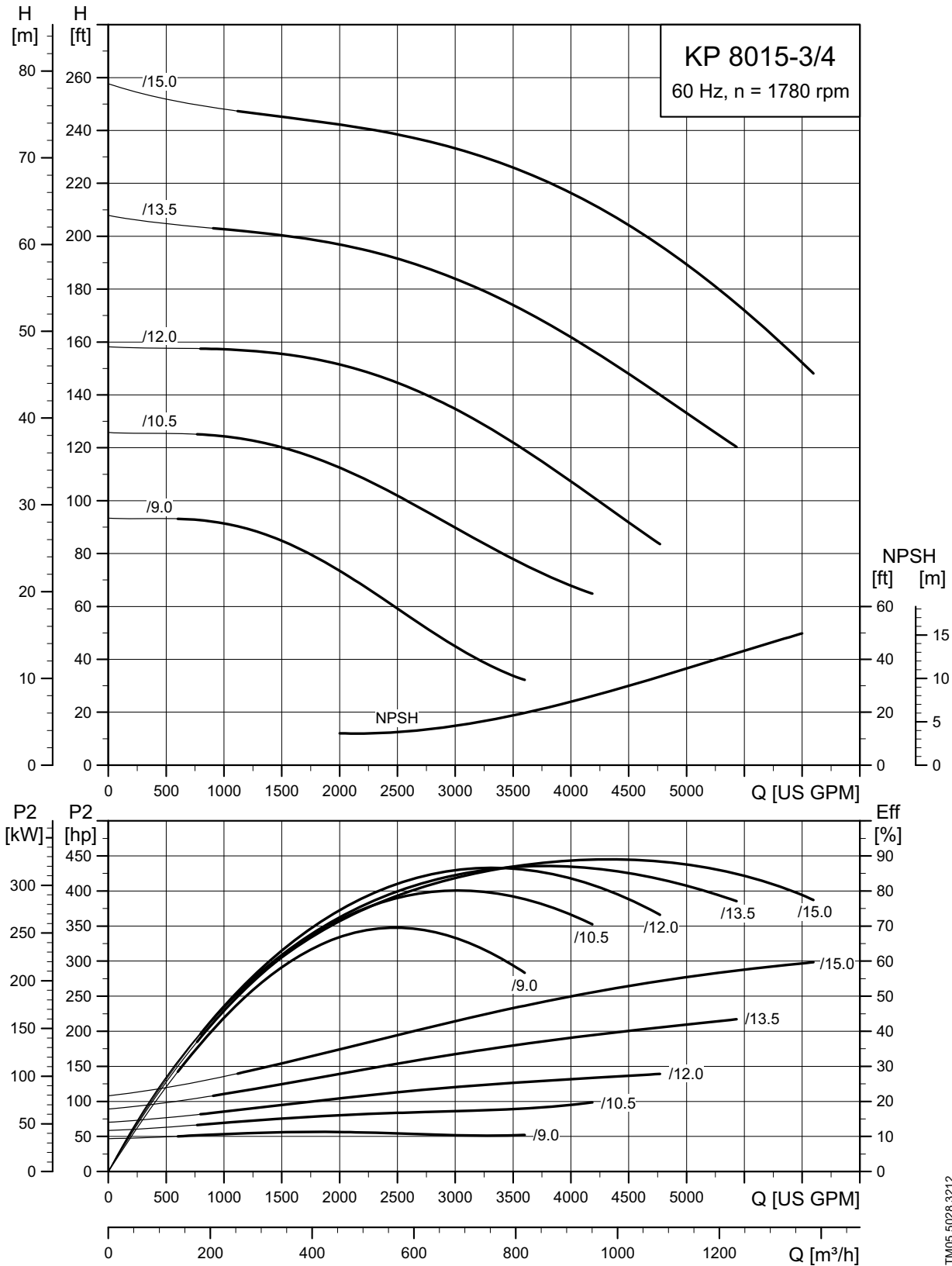

TM05 5028 3212

TM05 5028 3912

KP 8020-5/6 [4-pole]

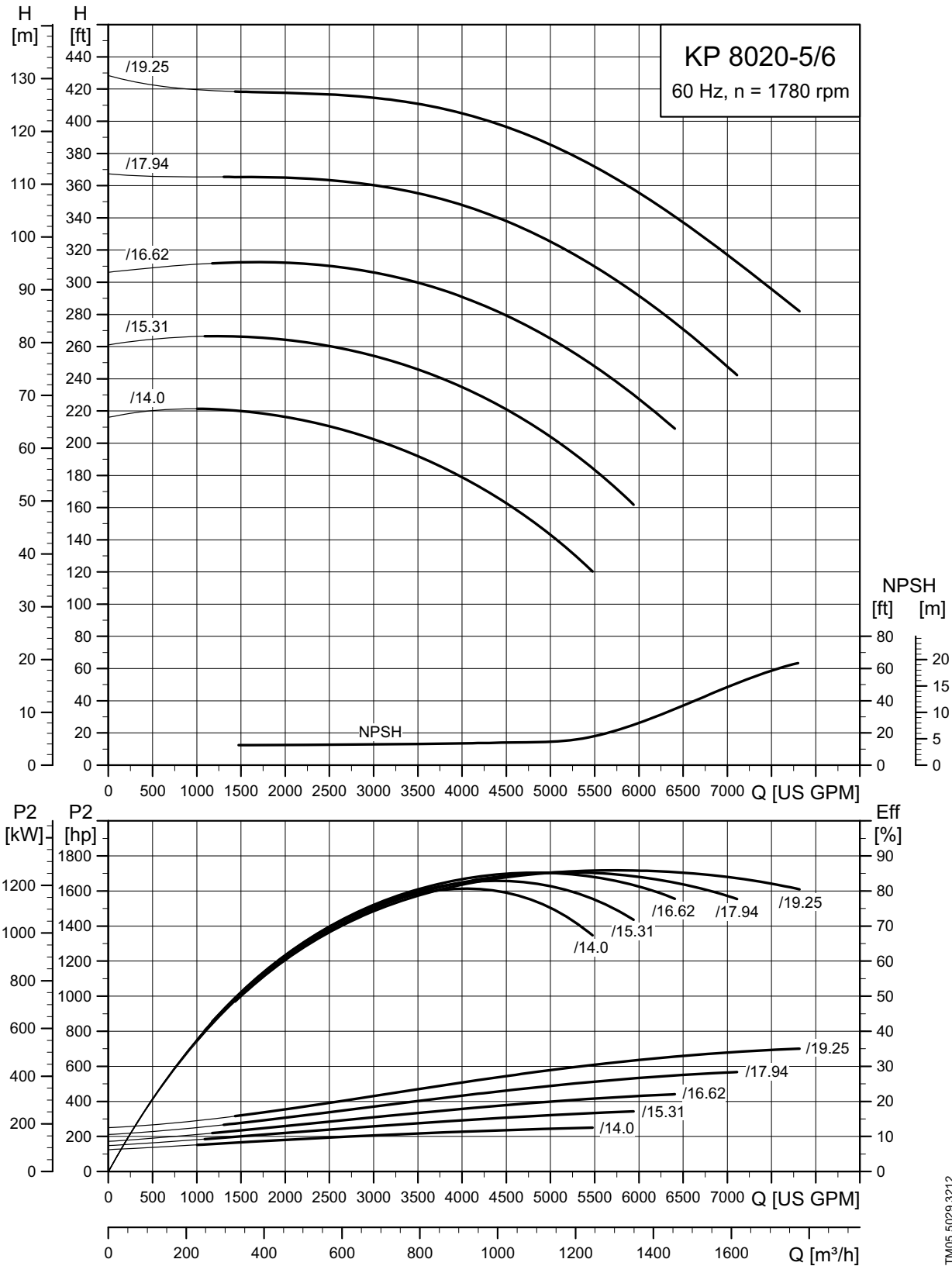

TM05 5029 3212

TM05 5029 3912

KP 1012-1/2 [4-pole]

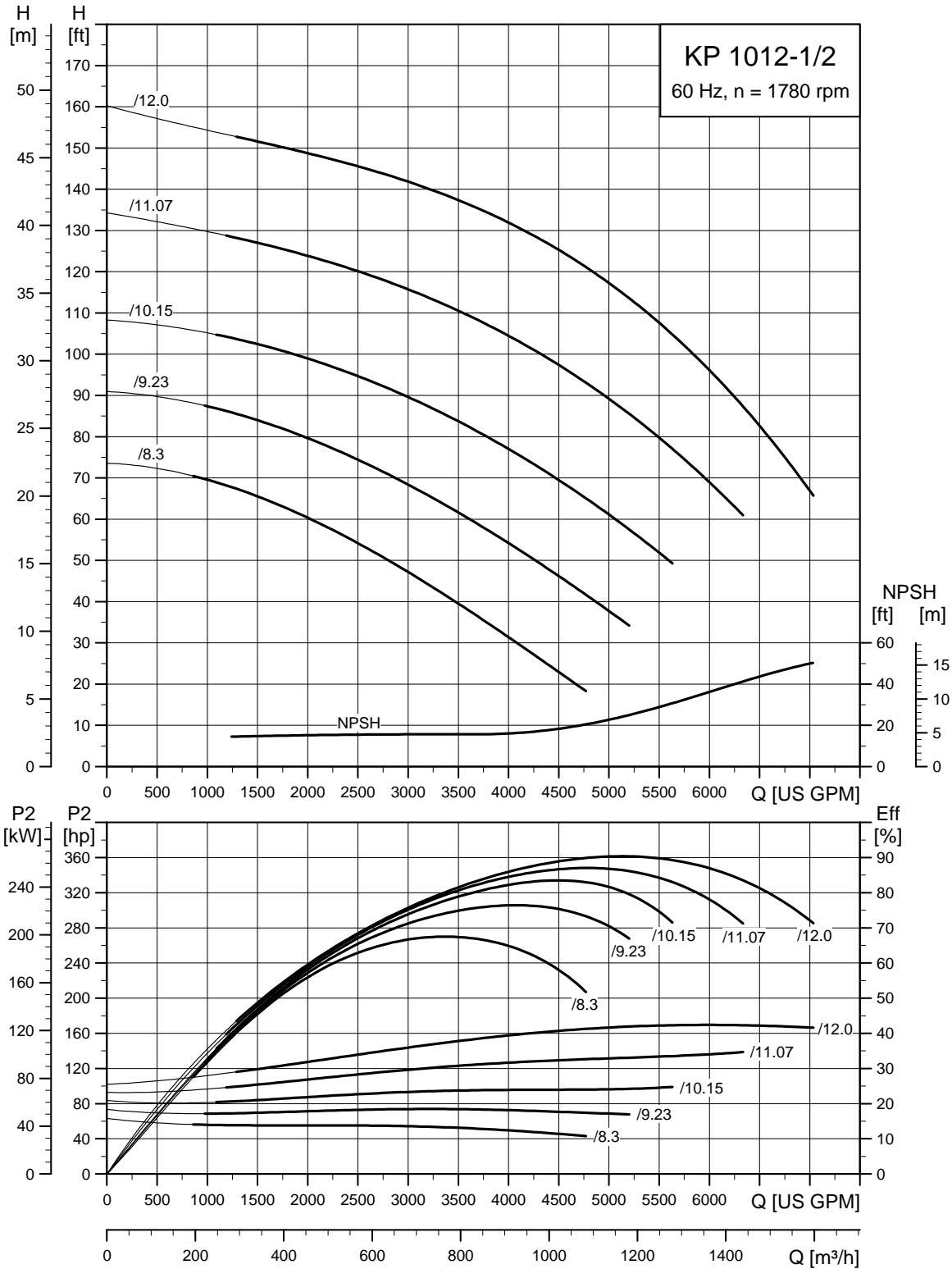

TM05 5030 3912

KP 1015-3/4 [4-pole]

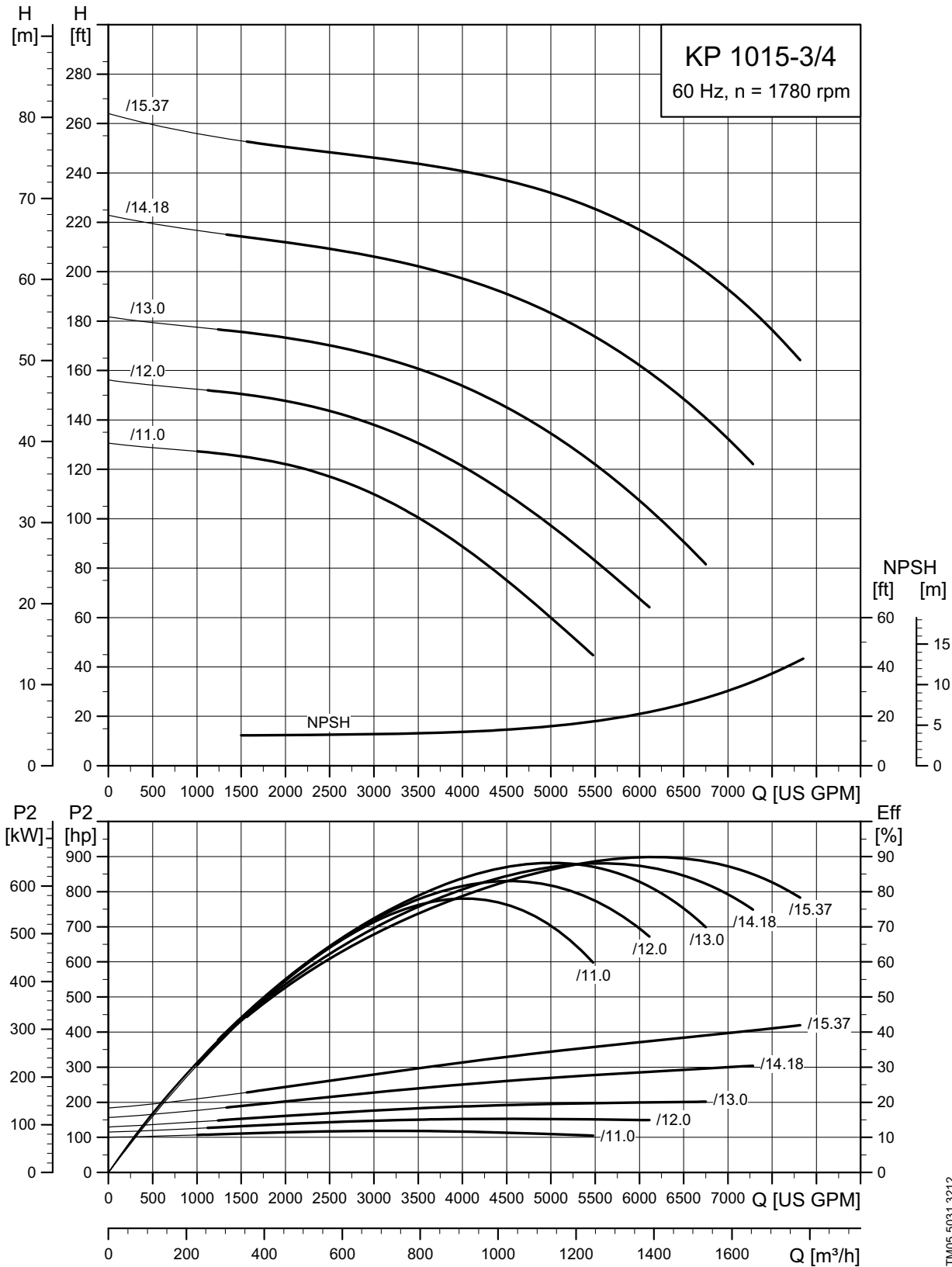

TM05 5031 3212

TM05 5031 3912

KP 1020-3/4 [4-pole]

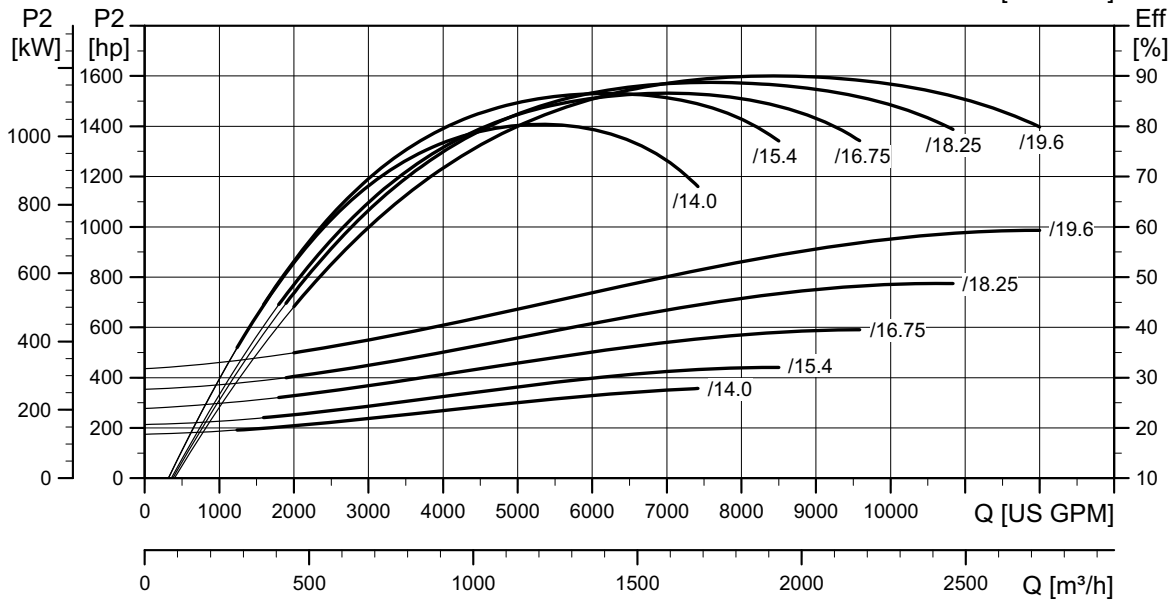
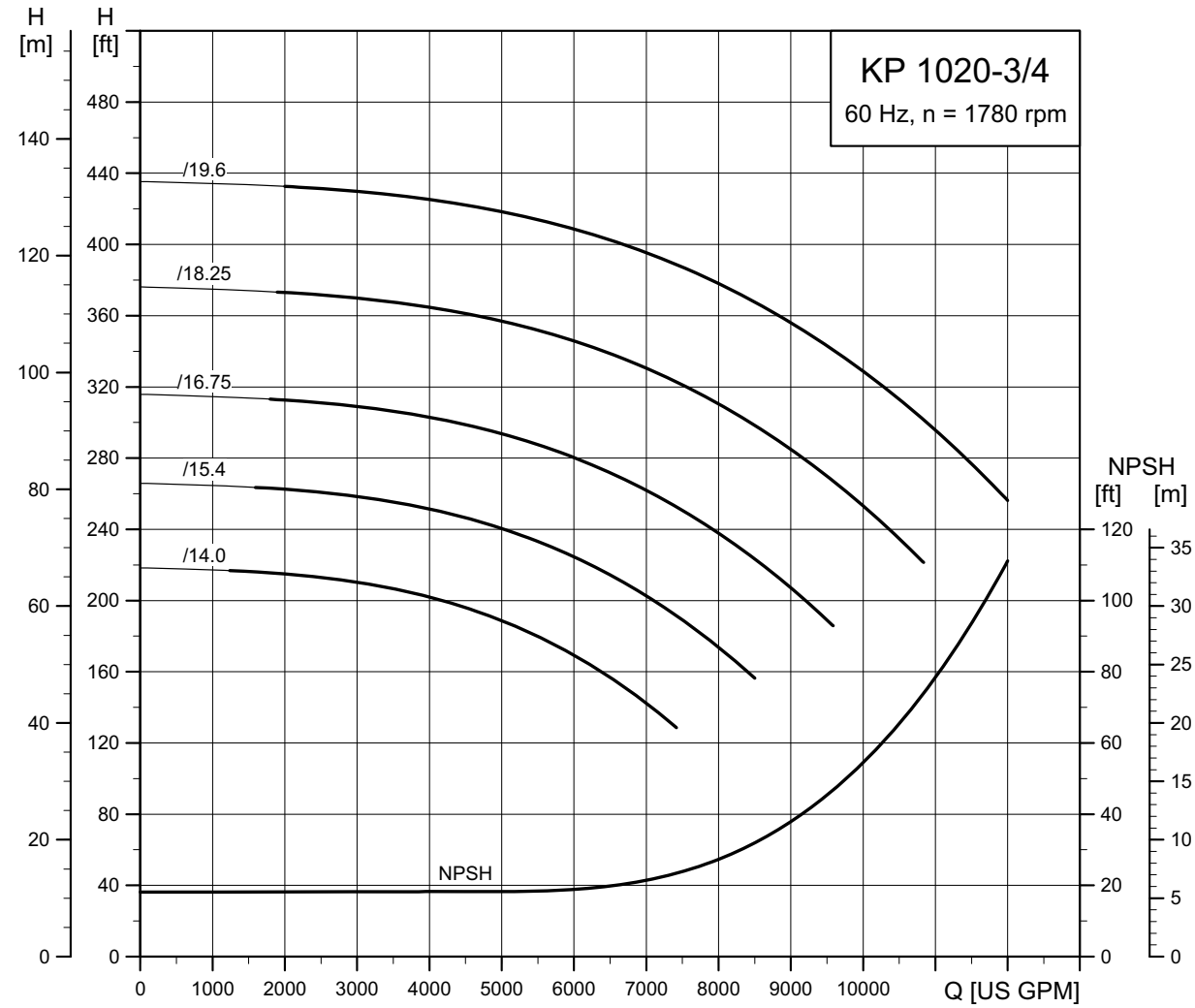

TM05 5032 3212

TM05 5032 3912

KP 1024-3/4 [4-pole]

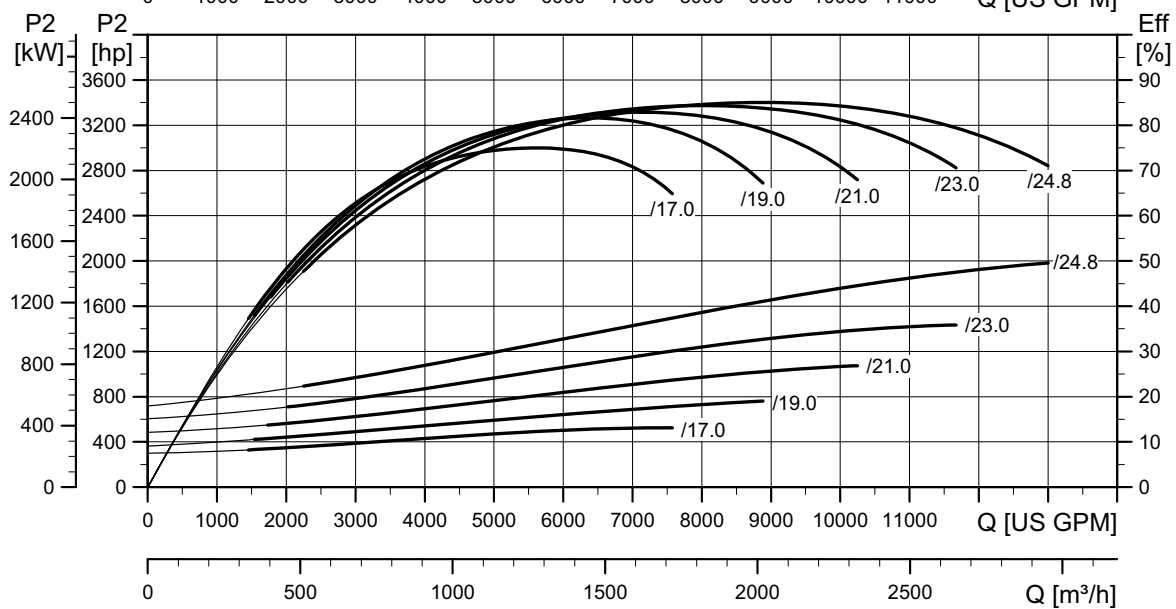
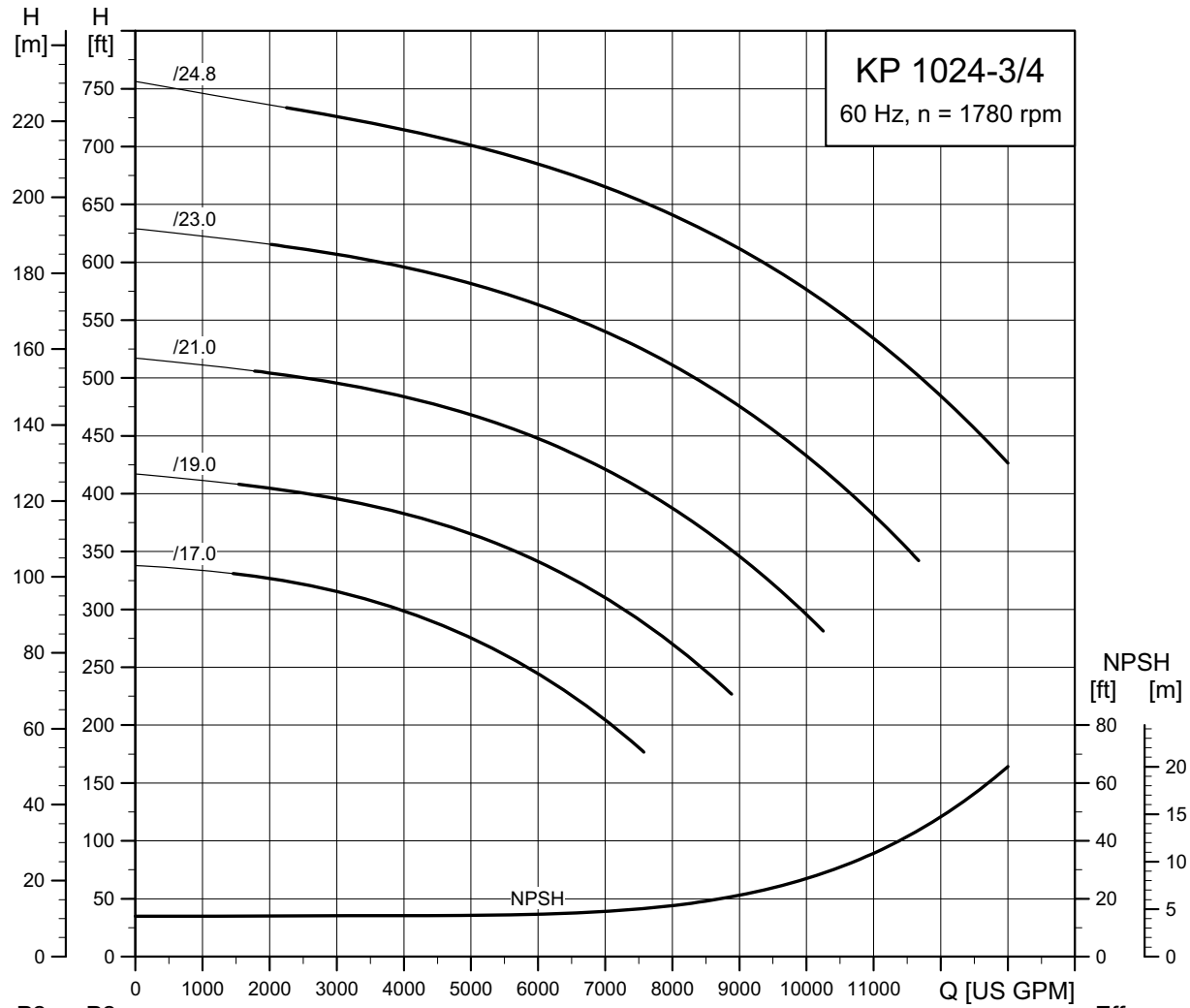

TM05 5033 3212

TM05 5033 3912

KP 1415-1/2 [4-pole]

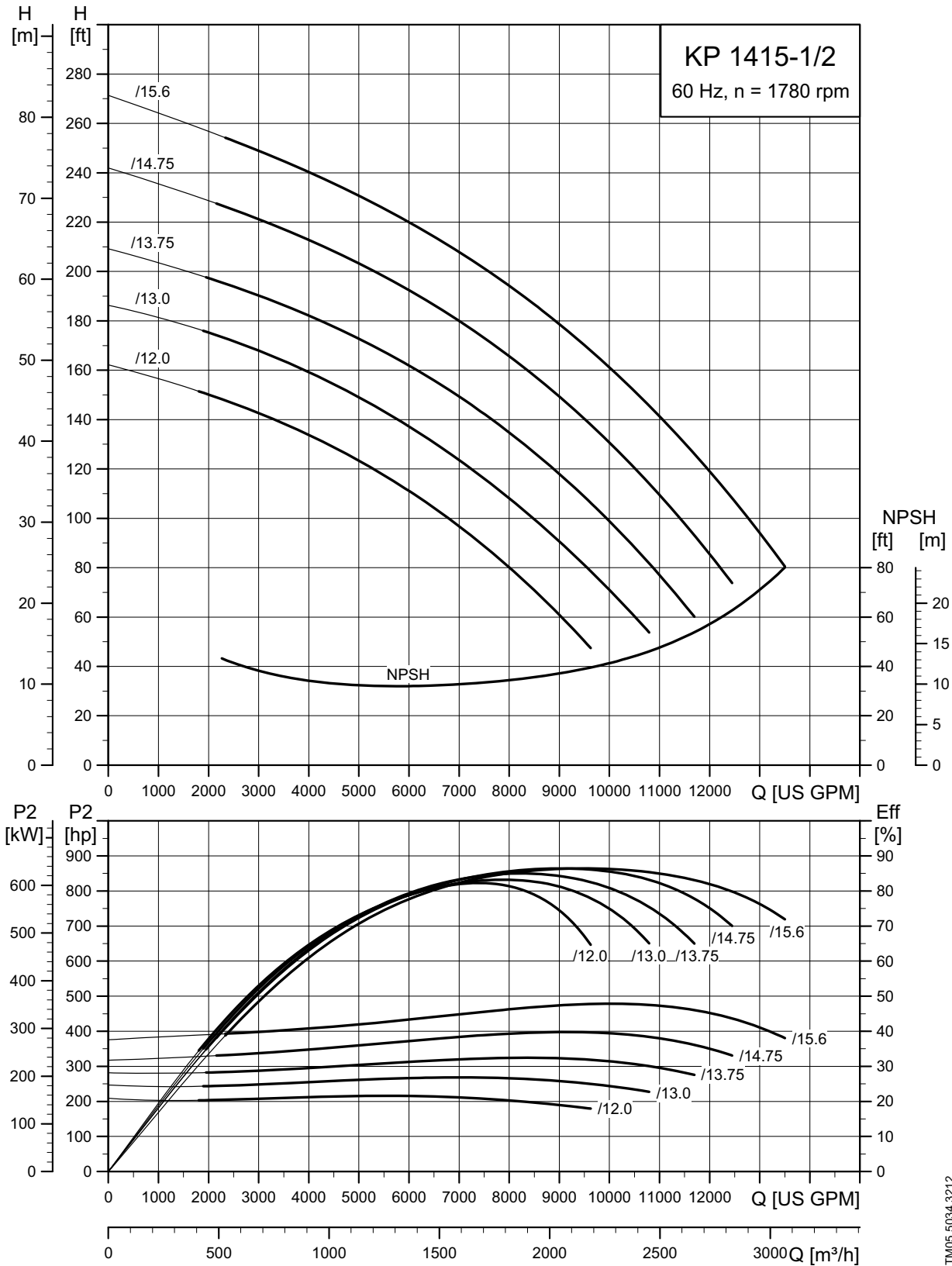

TM05 5034 3212

TM05 5034 3912

KP 6019-7/8 [6-pole]

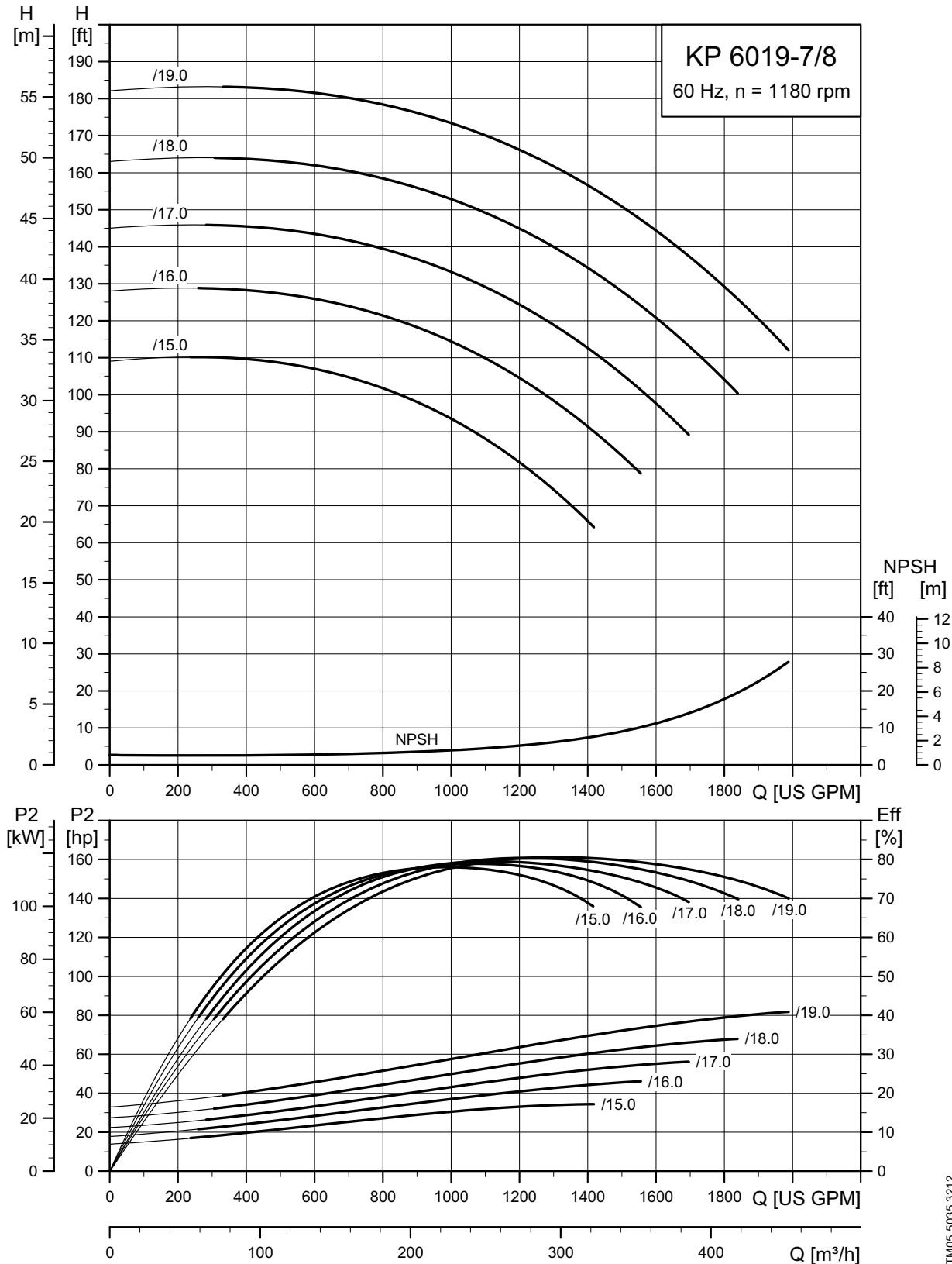

TM05 5035 3212

TM05 5035 3912

KP 6020-3/4 [6-pole]

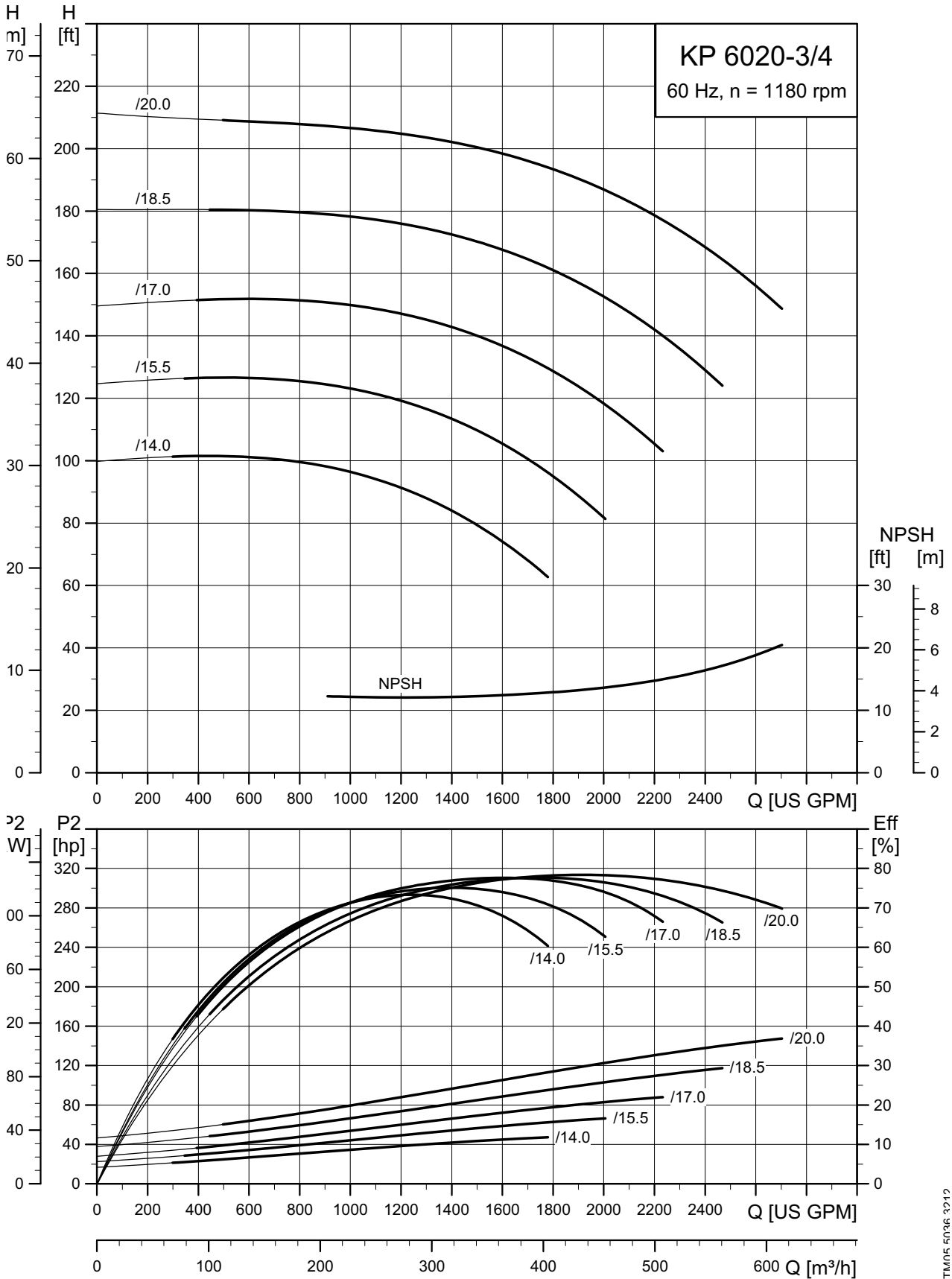

TM05 5036 3912
TM05 5036 3912

KP 8015-3/4 [6-pole]

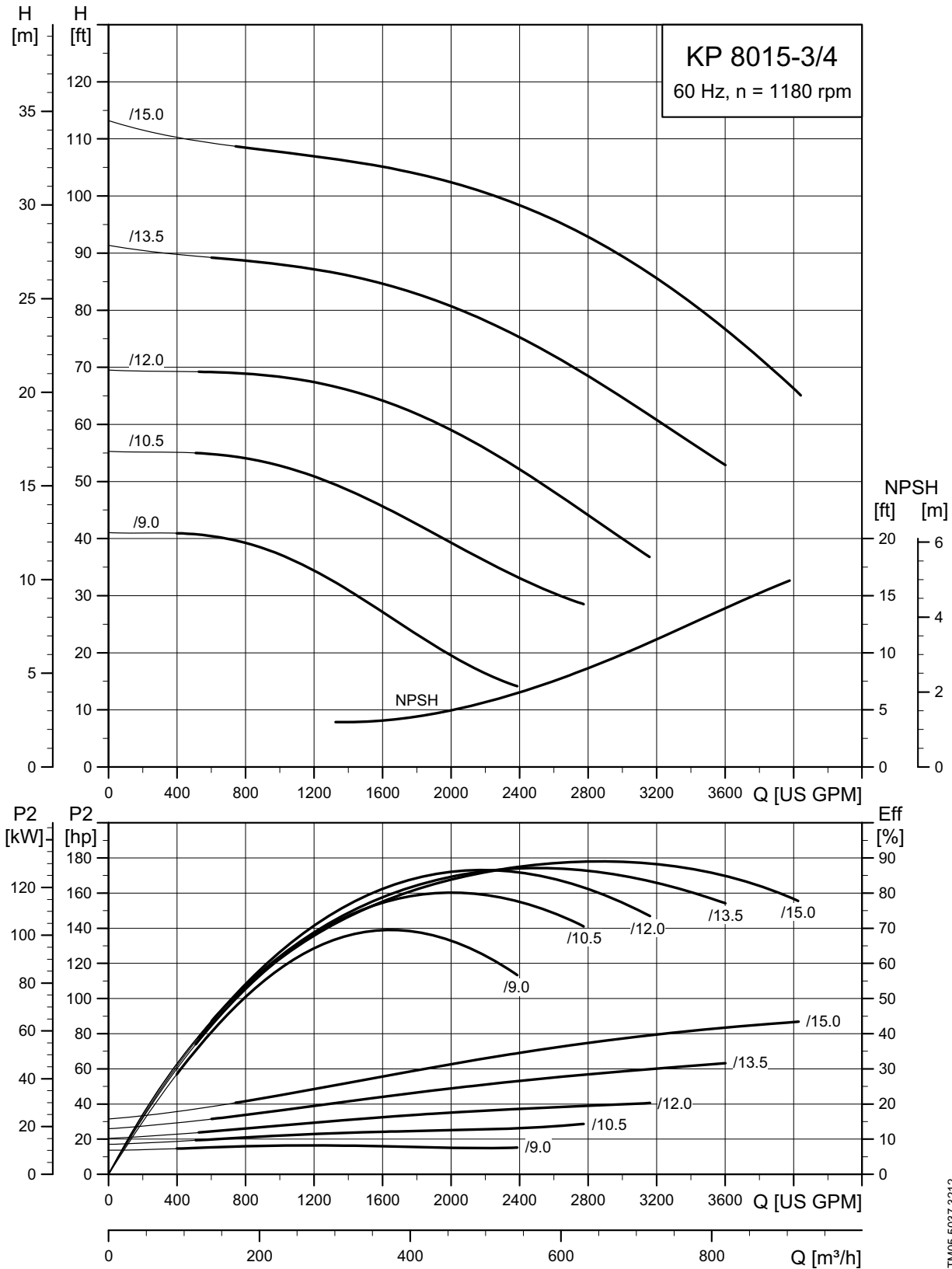

TM05 5037 3212

TM05 5037 3912

KP 8020-5/6 [6-pole]

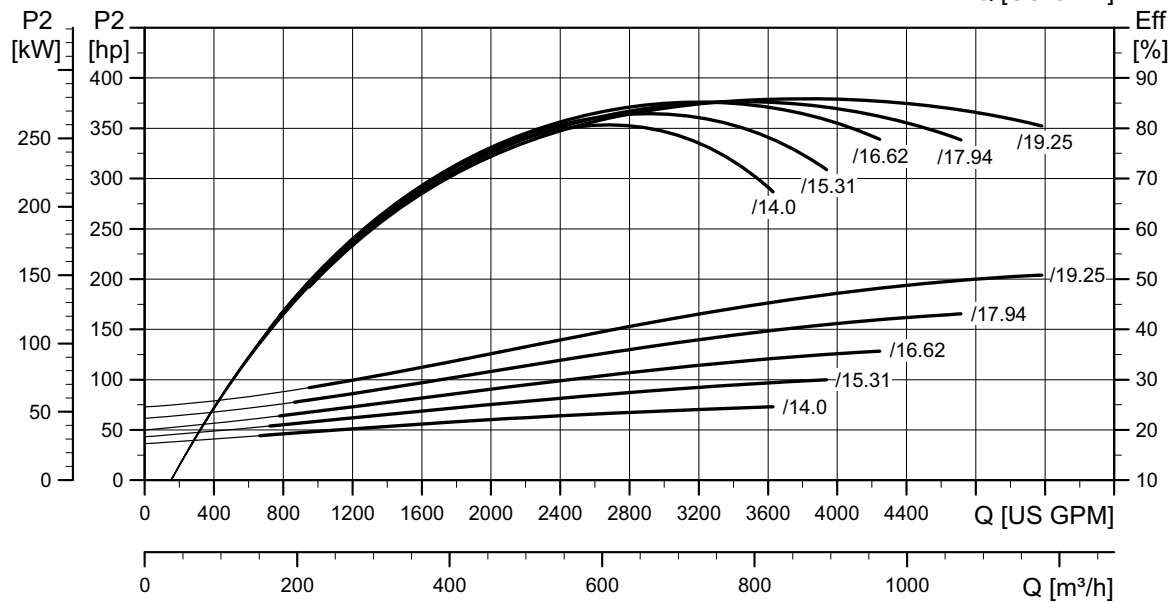
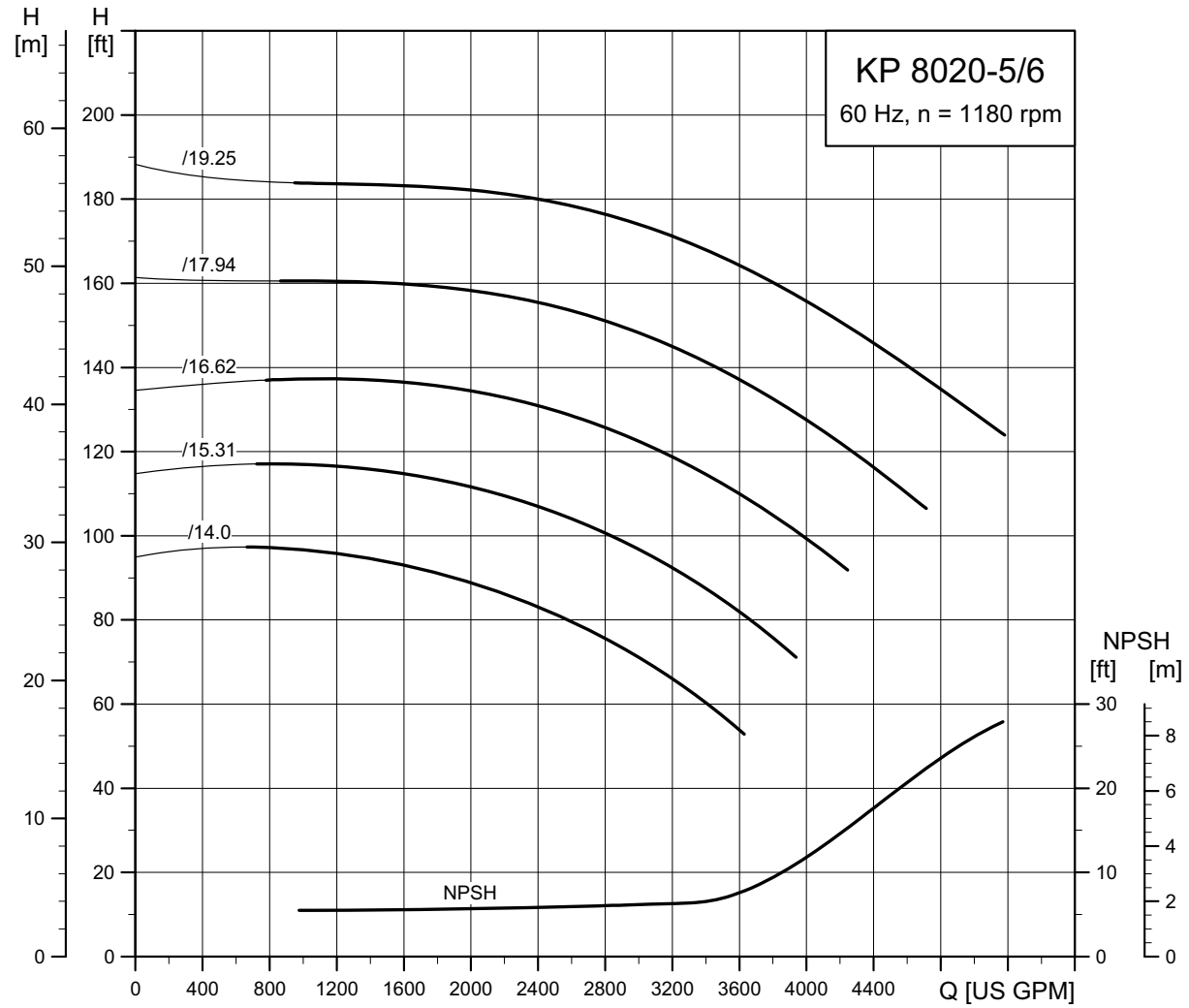

TM05 5038 3212

TM05 5038 3912

KP 1012-1/2 [6-pole]

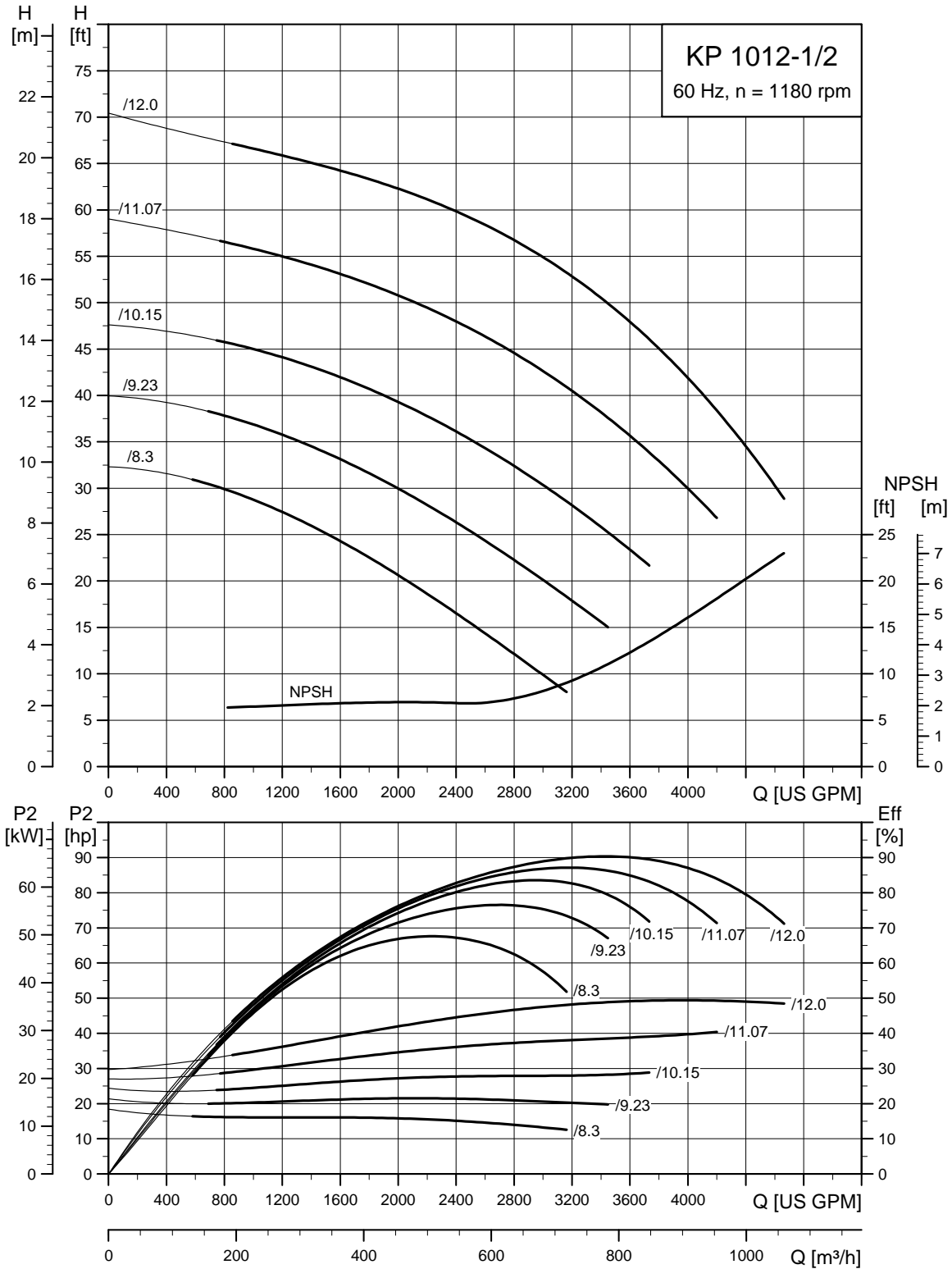

TM05 5039 3912

KP 1015-3/4 [6-pole]

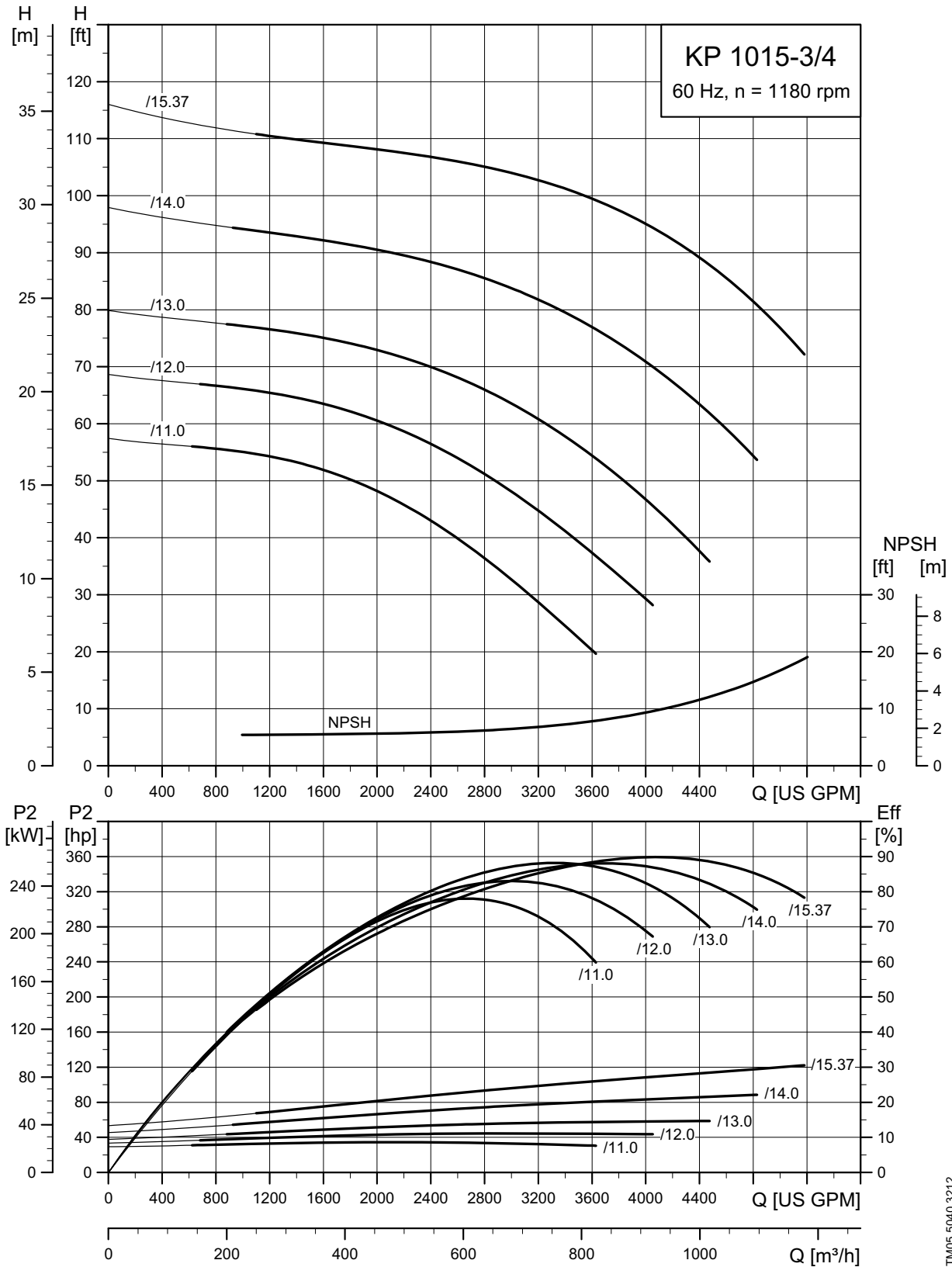

TM05 5040 3212

TM05 5040 3912

KP 1020-3/4 [6-pole]

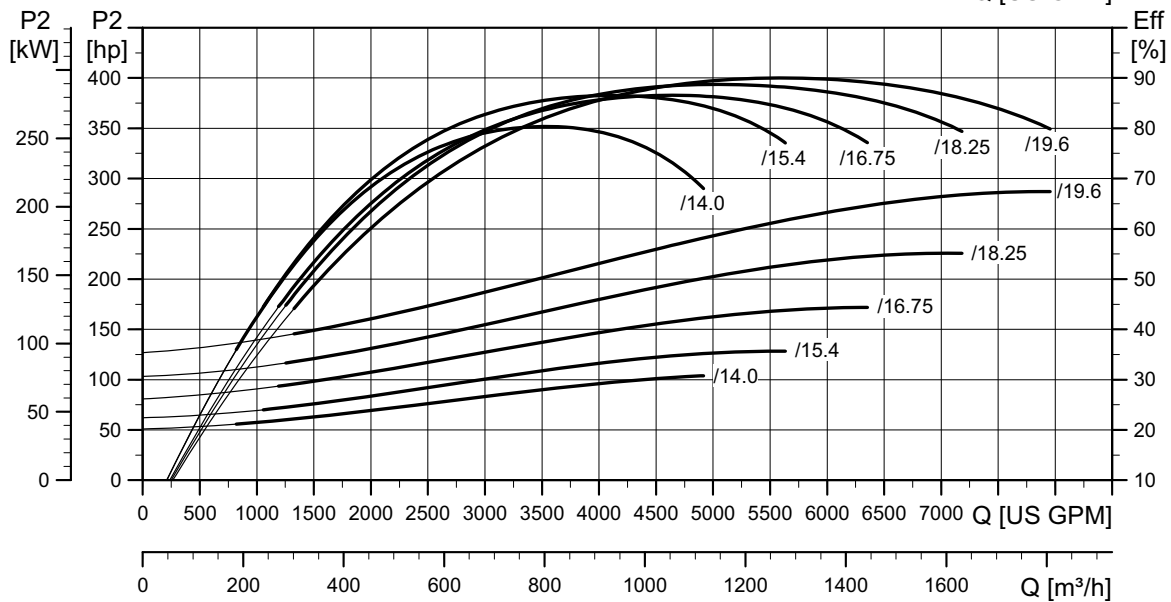
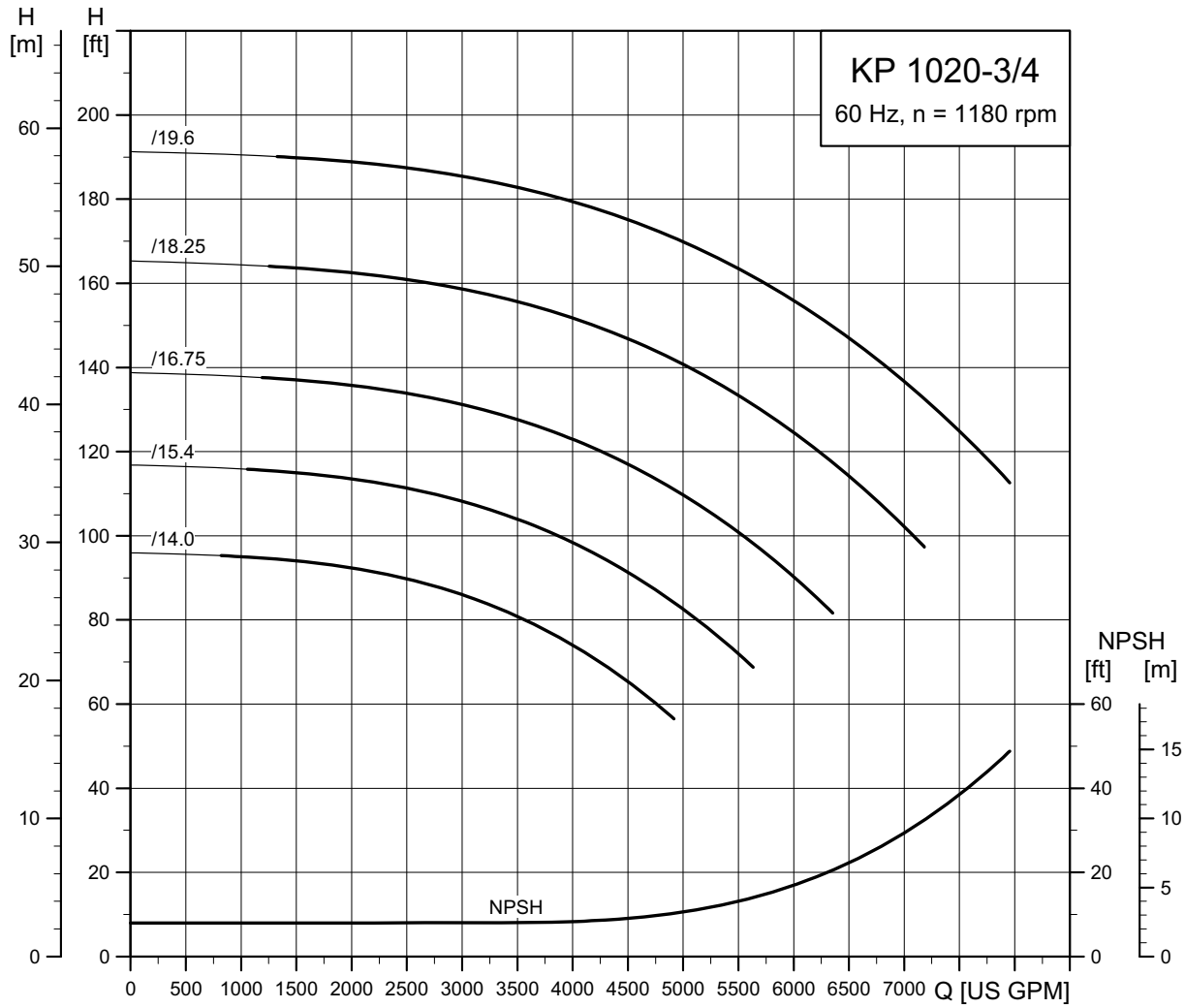

TM05 5041 3212

TM05 5041 3912

KP 1024-3/4 [6-pole]

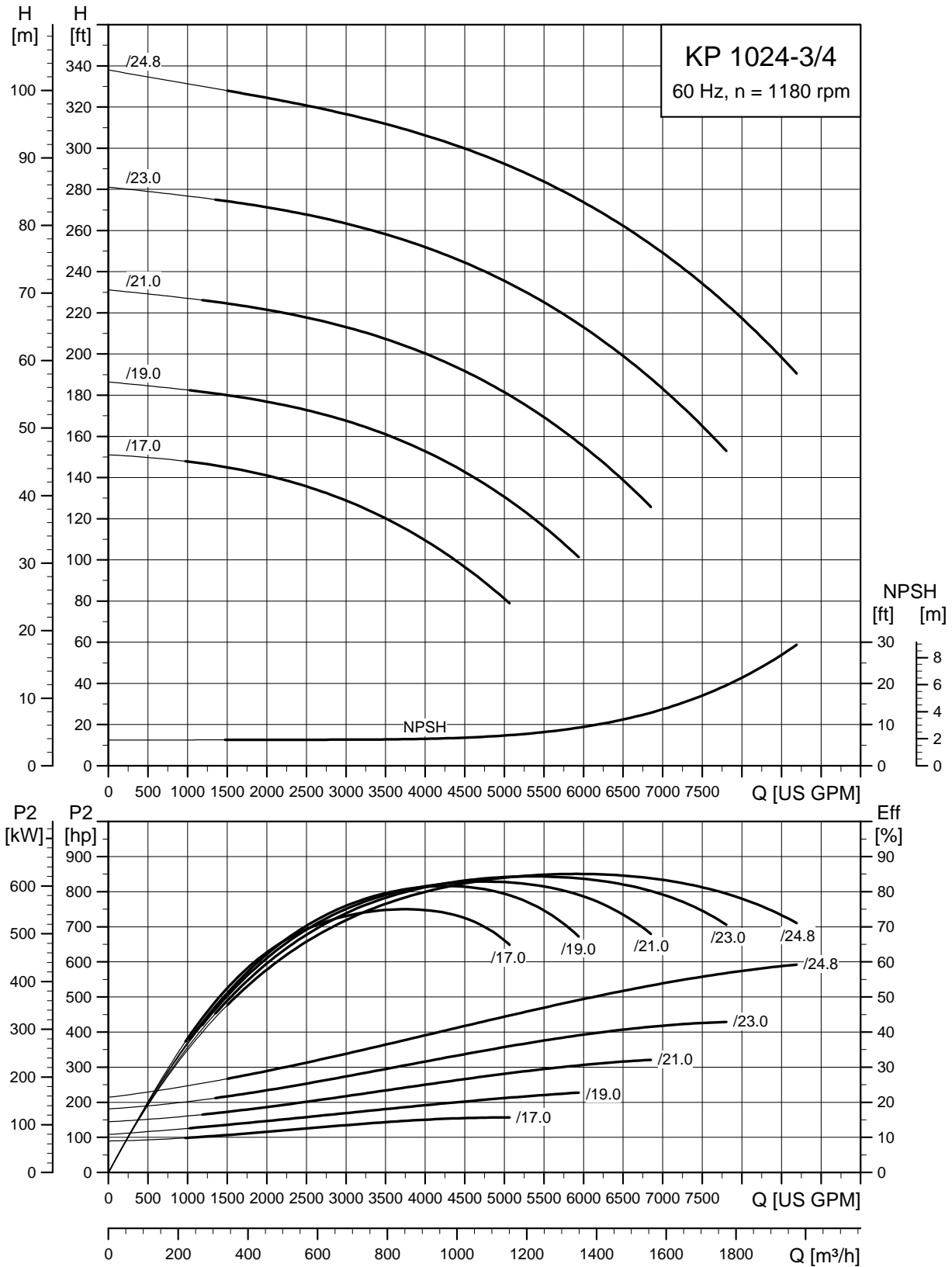

TM05 5042 3912

KP 1220-5/6 [6-pole]

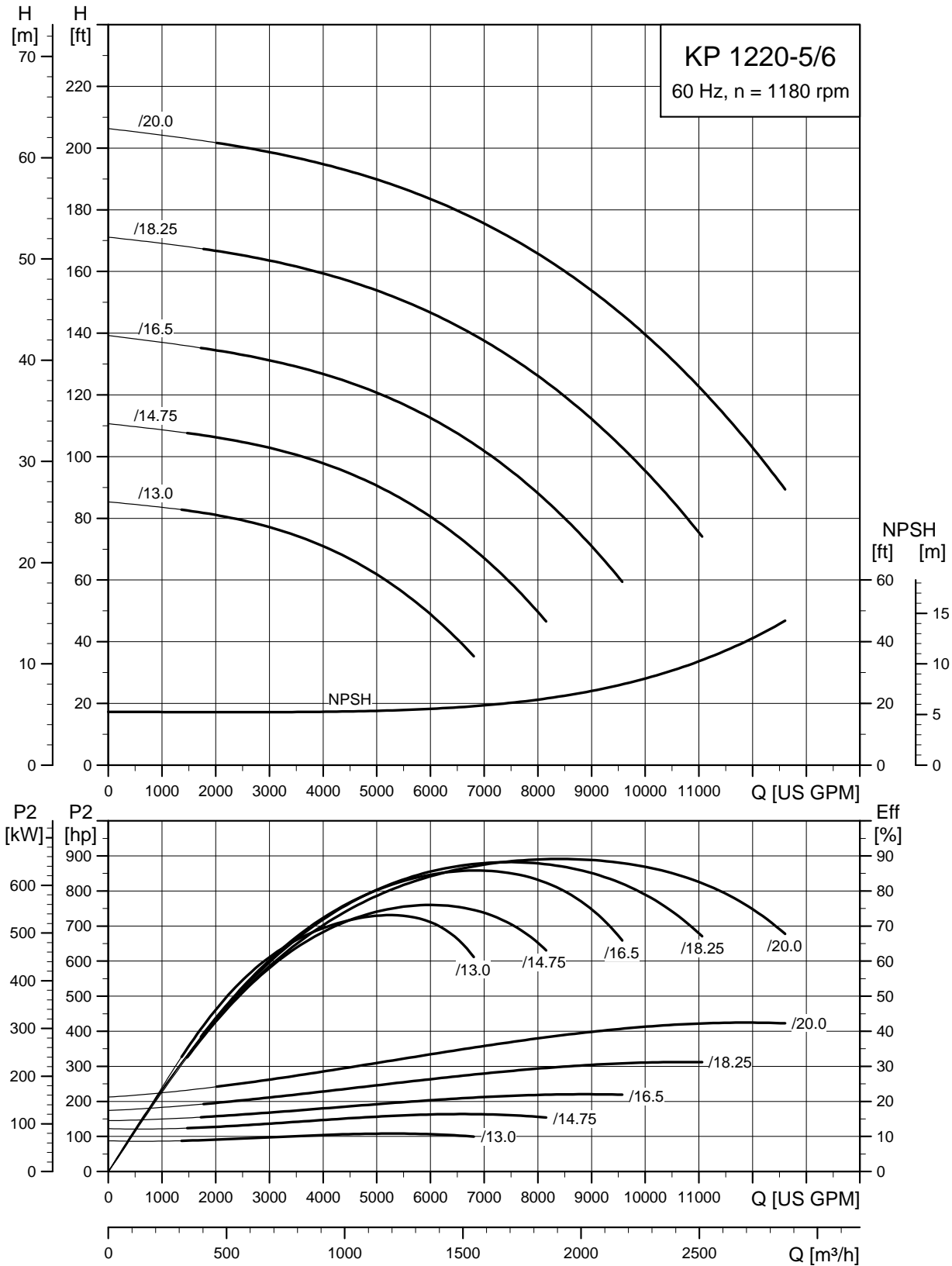

TM05 5043 3912

KP 1415-1/2 [6-pole]

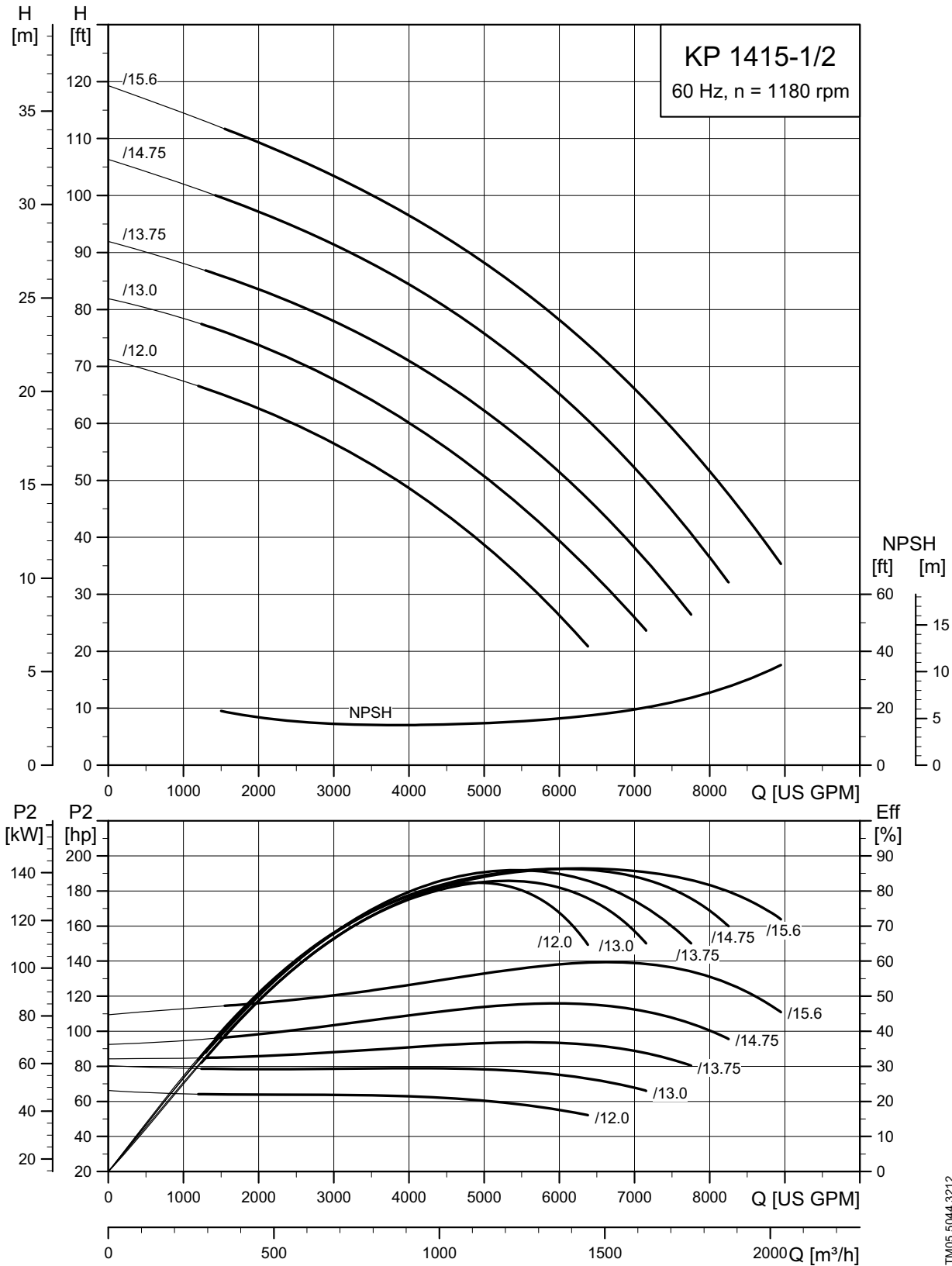

TM05 5044 3212

TM05 5044 3912

8. Bare shaft pump

Dimensional sketch

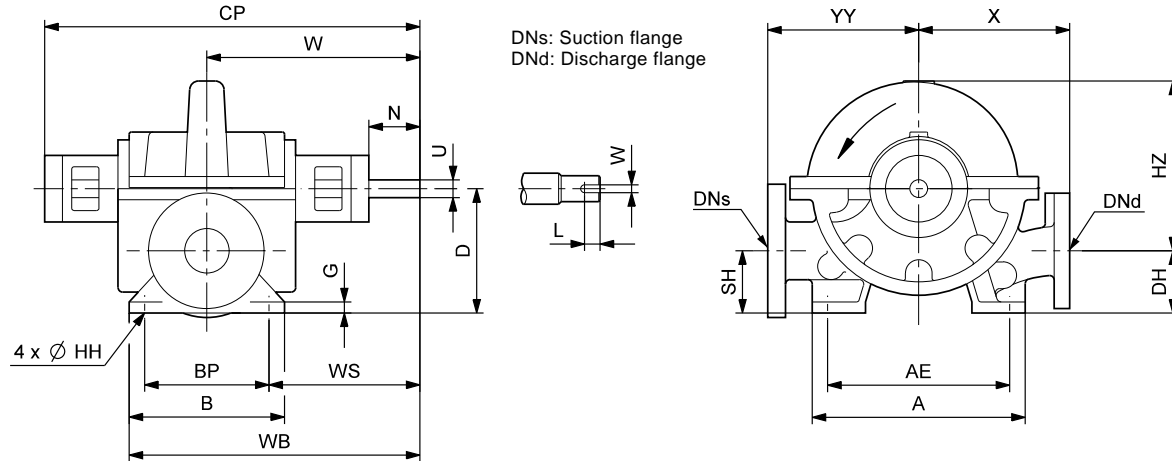

TM04 1827 1108

Dimensions

All dimensions are in inches.

Pump size	DNd	DNs	HZ	A	AE	D	BP	B	DH/SH	W	H
2095-1/2	2	2-1/2	12-1/4	12	10-1/4	7	7	8-3/4	3-1/2	12	11-16
2013-5/6	2	2-1/2	15-5/8	12	10-1/4	8-1/2	7	8-3/4	3-1/2	12	11/16
3095-7/8	3	4	13	12	10-1/4	8	7	8-3/4	4	12	11/16
3014-7/8	3	4	16-5/8	12	10-1/4	10	9-1/4	11	5	14-1/2	11/16
4012-1/2	4	5	16-1/8	12	10-1/4	10-1/8	9-1/4	11-1/8	4-7/8	14-1/2	11/16
4012-7/8	4	5	16-1/8	12	10-1/4	10-1/8	9-1/4	11-1/8	4-7/8	14-1/2	11/16
4015-9/0	4	5	20	12	10-1/4	13	12	13-3/4	6-1/4	14-1/2	11/16
5012-7/8	5	6	17-5/8	12	10-1/4	14-1/2	10-1/4	12	6-1/2	16-1/2	11/16
5015-9/0	5	6	20-3/4	12	10-1/4	16-1/8	10-1/4	12	6-1/2	17	11/16
6012-3/4	6	8	19-3/4	12	10-1/4	16	10-1/4	12	6-1/2	17	11/16
6015-3/4	6	8	22-3/4	12-1/4	10-1/4	18-1/4	16-1/2	18	7-1/4	20	11/16
6019-7/8	6	8	23-3/4	12	10-1/4	17	12	14	6-3/4	19-1/4	3/4
6020-3/4	6	8	25-5/8	12-1/2	10-1/4	17-3/4	12	14	6-3/4	21-1/2	3/4
8012-5/6	8	10	21-5/8	12	10-1/4	17-1/4	14	15-1/2	6-3/4	20	11/16
8015-3/4	8	10	24-3/4	12-3/4	10-1/4	19	17-1/2	19-1/2	7	20-3/8	11/16
8020-5/6	8	12	28-13/16	25-1/2	19-3/4	20-13/16	16	19-1/4	7-13/16	29-1/2	1-1/8
1012-1/2	10	12	24-3/8	12-3/4	10-1/4	19-13/16	17-1/2	19-1/2	8	20-7/8	11/16
1015-3/4	10	12	24-3/4	18	15	20	12	14	10	23-5/8	7/8
1020-3/4	10	14	30-3/8	25-1/2	19-3/4	23-1/16	16	19-1/4	9-11/16	31-7/16	1-1/8
1024-3/4	10	14	31-3/4	25-1/2	19-3/4	25	16	19-1/4	12	31-7/16	1-1/8
1220-5/6	12	14	30-13/16	25-1/2	19-3/4	25	16	19-1/4	12	31-7/16	1-1/8
1415-1/2	14	16	30-1/2	-	-	-	-	-	-	28-1/2	-

Dimensional sketch

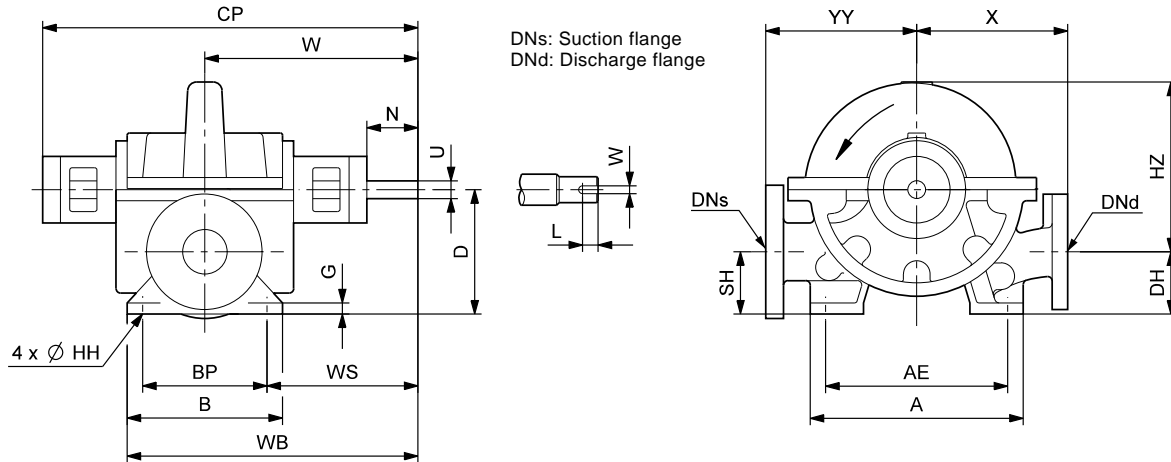

TM04 1827 1108

Dimensions

All dimensions are in inches.

Pump size	K(WxL)	YY	X	G	U	N	WS	CP		WB
								PACK	SEAL	
2095-1/2	1/4x1/8	8-1/2	8-1/2	5/8	1	2-7/8	8-1/2	21-1/8	19-3/4	16-3/8
2013-5/6	1/4x1/8	10	10	5/8	1	2-7/8	8-1/2	21-1/8	19-3/4	16-3/8
3095-7/8	1/4x1/8	11	11	3/4	1 XE 1-3/16	2-7/8	8-1/2	21-1/8	19-3/4	16-3/8
3014-7/8	3/8x3/16	12	12	7/8	1-1/2	2-3/4	9-7/8	26-1/4	24-1/2	20
4012-1/2	3/8x3/16	12	12	7/8	1-1/2	2-3/4	9-7/8	26-1/4	24-1/2	20
4012-7/8	3/8x3/16	12	12	7/8	1-1/2	2-3/4	9-7/8	26-1/4	24-1/2	20
4015-9/0	3/8x3/16	14-1/16	14-1/16	1	1-1/2	2-3/4	8-1/2	26-1/4	24-1/2	21-3/8
5012-7/8	3/8x3/16	13	13	1	1-1/2	2-3/8	11-3/8	30-1/4	30-1/4	22-1/2
5015-9/0	3/8x3/16	15	14	1	1-1/2	2-3/8	11-7/8	31-1/4	31-1/4	23
6012-3/4	3/8x3/16	16	14	1	1-1/2	2-3/8	11-7/8	31-1/4	31-1/4	23
6015-3/4	3/8x3/16	16	15	1-1/8	1-3/4	3-11/16	11-3/4	36-5/16	36-5/16	29
6019-7/8	(X5)3/8x3/16 (X6)1/2x1/4	17	17	1	(X5)1-3/4 (X6)2	(X5)3-11/16 (X6)3	13-1/4	(X5)34-11/16 (X6)35-1/2	(X5)34-3/16 (X6)35-1/2	26-1/4
6020-3/4	1/2x1/4	19	17	1	2-1/8	3-16/16	15-1/2	39-1/8	39-1/8	28-1/2
8012-5/6	3/8x3/16	17	15	1-1/8	1-3/4	3-11/16	13	36-5/16	36-5/16	27-3/4
8015-3/4	3/8x3/16	19	19	1-1/8	1-3/4	3-11/16	11-5/8	37-1/16	37-1/16	30-1/8
8020-5/6	5/8x5/16	22	16-5/16	1-3/8	2-1/2	4-1/4	21-1/2	53-11/16	53-11/16	39-1/8
1012-1/2	3/8x3/16	19-1/2	19-1/2	1-1/8	1-3/4	3-11/16	12-1/8	38-1/16	38-1/16	30-5/8
1015-3/4	1/2x1/4	23	17	1-1/8	2-1/4	6-1/8	17-5/8	41-1/8	41-1/8	30-5/8
1020-3/4	3/4x3/8	26	20	1-3/8	3-1/8	6-7/8	23-3/8	54-11/16	54-11/16	41-5/16
1024-3/4	3/4x3/8	28	24	1-3/8	3-1/8	9-5/16	23-3/8	53-1/2	53-1/2	41-5/16
1220-5/6	5/8x5/16	28	23	1-3/8	2-1/2	4-1/4	21-1/2	54-3/4	54-3/4	39-1/8
1415-1/2	-	25-3/5	21-13/20	-	2-1/2	-	-	51-7/10	51-7/10	-

98432075 0413

ECM: 1109068

GRUNDFOS Pumps Corporation

17100 West 118th Terrace
Olathe, Kansas 66061
Phone: +1-913-227-3400
Telefax: +1-913-227-3500

GRUNDFOS Canada Inc.

2941 Brighton Road
Oakville, Ontario L6H 6C9
Canada
Phone: +1-905 829 9533
Telefax: +1-905 829 9512

Bombas GRUNDFOS de Mexico S.A. de C.V.

Boulevard TLC No. 15
Parque Industrial Stiva Aeropuerto
Apodaca, N.L. Mexico 66600
Phone: +52-81-8144 4000
Telefax: +52-81-8144 4010