

R Model 7180 Series Hydraulic Lube-Oil Filter

Designed for use with 718 and 736 style filter cartridges. Flows to 100 GPM.

The 7180 series Hydraulic lube filters are ideal for your oil reclamation and maintenance operations.

The 7180 series housings incorporate an eyenut cover that is easily removed, reducing time spent on cartridge change-out. The side-in/side-out piping arrangement is available in 1", 1-1/2", and 2" NPT connection sizes. Housings are electropolished creating a smooth, easy-to-clean surface.

The 7180 series accepts single 718 or 736 style filter cartridges, and are rated at 1 μ absolute to 100 μ nominal. They seal on the housing's elevated pedestal and are retained by a threaded post and cap assembly.

Keep your filtration process cost effective without sacrificing quality.



DUPLEX MODEL D8-7182

Applications

- Bulk Oil Handling
- Lubrication Oils
- Coolants
- Process Liquids
- Cutting Oils
- Quench Oils
- Fuels
- Rolling Mill Oils
- Hydraulic Oils
- Solvents

Features

- Permanently piped housings are opened without special tools
- Carbon steel housings or 304 and 316 stainless steel
- Covers are O-ring sealed
- 150 psi rated housing
- 1", 1-1/2", or 2" NPT inlet and outlet
- 1/4" NPT vent connection

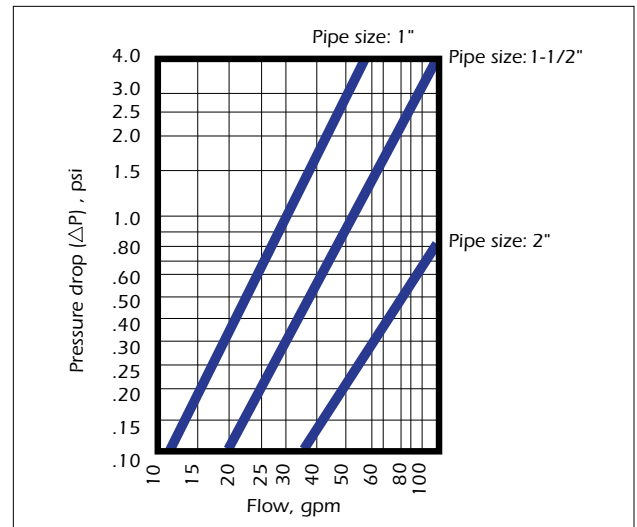

*Based on housing only. Fluid viscosity, filter bag used, and expected dirt loading should be considered when sizing a filter.

R How To Order

Build an ordering code as shown in the example.

Example : **8-7181 - 2P - 2 - 150 - C - V - C**

MODEL

- 8-7181** (single element)
- 8-7182** (double element)
- D8-7181** (duplex single element)
- D8-7182** (duplex double element)

PIPE SIZE

- 1-inch female NPT = **1P**
- 1-1/2-inch female NPT = **1-1/2P**
- 2-inch female NPT = **2P**

OUTLET STYLE

- Side / Side = **2**

PRESSURE RATING

- 100 psi = **150**

HOUSING MATERIAL

- Carbon steel = **C**
- Stainless steel = **S**
- 316 Stainless steel = **S316**

COVER SEAL

- Buna N = **B**
- Ethylene propylene = **E**
- Viton® Fluoroelastomer = **V**

ASME CODE STAMP

- ASME Code Stamp = **C**

Weight (approximately): 70 lbs. (Model 8-7181)

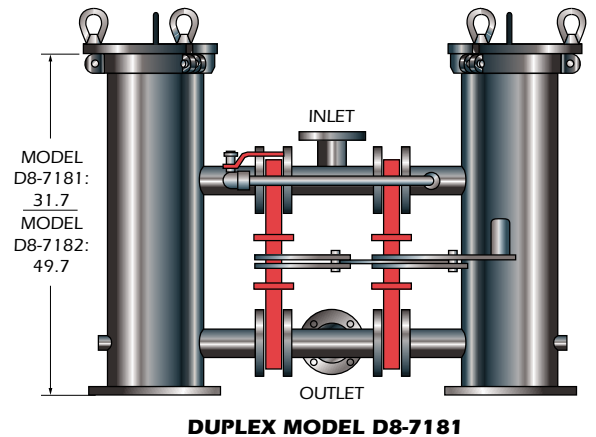
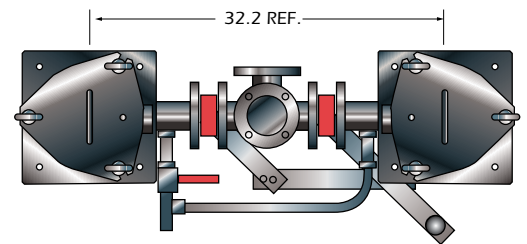
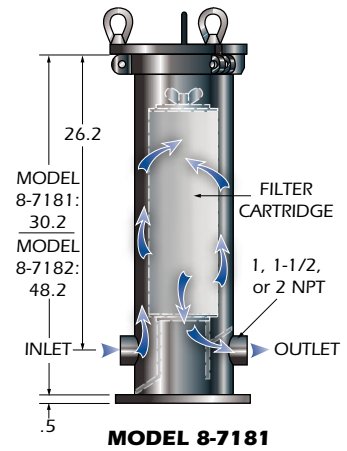
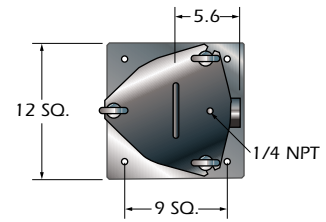

Dimensions are reference only and should not be used for hard plumbing. Consult factory for certified drawings.

R 718 and 736 Filter Cartridges

For Use With the 7180 Housing.
Flows to 100 GPM.

The Rosedale 718 and 736 style filter cartridges, are rated at 1μ β 1000 to 100μ nominal.

Specifications

Filtration Ratings:

95% at 1, 5, 10, 20, and 30μ m

Filter Media:

Phenolic Impregnated Cellulose

Perforated Sleeve & Core, End Caps:

ETP Steel

Adhesive:

Thermosetting PVC

End Seals:

Buna-N Gasket Standard

Recommended Operating Conditions:

Maximum Temperature: 250°F (121°C)

Change-Out Δ P: 25 PSID (1.7 BAR)

Maximum Flow Rate:

718 Series: 50 GPM

736 Series: 100 GPM

Size:

718: 6" OD x 18.1" Long

736: 6" OD x 36.1" Long

(ID is 2-5/8" or 2-1/8")

Shipping Weight:

718: 20 lb (6 per carton)

736: 40 lb (6 per carton)



Liquid Particle Retention Ratings (μ m) at Removal Efficiencies Of:

Cartridge	$\beta=1000$ 99.9%	$\beta=75$ 98.7%	$\beta=20$ 95%
1	12	3	1
5	25	18	5
10	40	25	10
20	50	40	20
30	85	60	40

How To Order

Build an ordering code as shown in the example.

Flow vs Differential Pressure

718: 1/2 to 1 Microns

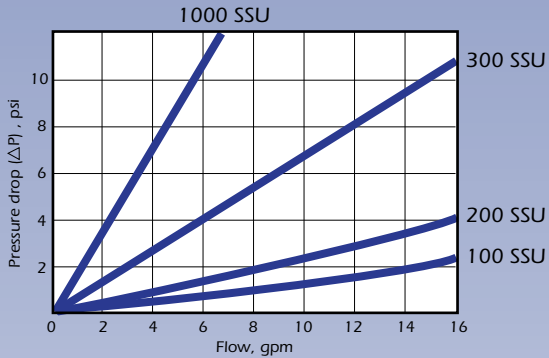

718: 5 to 10 Microns

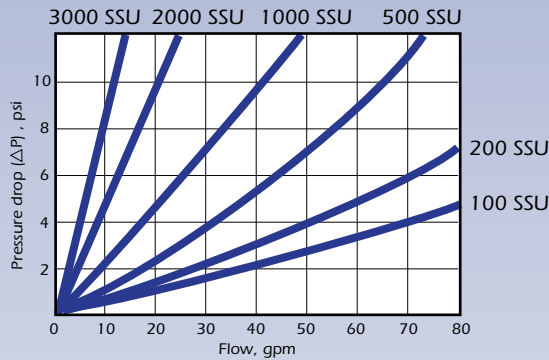

718: 20 to 100 Microns

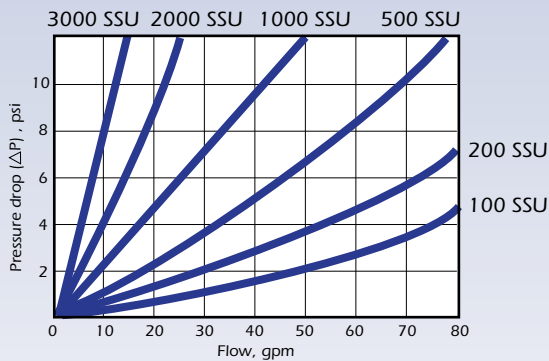

Example : **718 - 10 - 8 - V - None**

MODEL
18.1" x 6.25" = **718**
36.1" x 6.25" = **736**

MICRON RATING
1, 5, 10, 20, 30

INSIDE DIAMETER

2-5/8 Inch = **None**
2-1/8 Inch = **8**

COVER SEAL

Buna N = **None**
Cork = **C**
Vellumoid = **V**

PERFORATED SLEEVE & CORE

ETP Steel = **None**
No Sleeve & Core = **N**

