



FILTRATION SPECIFICATIONS

Filter: Model 4 Basket Strainers and Bag Filters

Model 4 strainer/filter housings are made in 2 basket sizes and 2 pressure ratings. In all cases, covers are easily removed without special tools, and the basket or bag is easily cleaned or replaced.

FEATURES

- Carbon steel or stainless steel (304 or 316) construction for housings
- O-ring seals: Buna N, EPR, Fluoroelastomer, PTFE
- Two pressure ratings: 200 psi (with clamp cover) and 500 psi (with eyenut cover)
- Pipe sizes 1-inch thru 2-inch, NPT
- Two basket depths: 6 or 12 inches

OPTIONS

- Liquid Displacers
- Magnets
- Adjustable Legs
- ASME Code Stamp





FILTRATION SPECIFICATIONS

Filter: Model 4 Basket Strainers and Bag Filters

PRESSURE DROP DATA

Basket strainers and bag filters are usually selected so that the pressure drop does not exceed 2 psi when they are clean. Higher pressure drops may be tolerated when contaminant loading is low. Bag change-out should occur at 15 psid.

The pressure drop data is determined by the steps below:

FOLLOW THESE EASY STEPS:

- 1. Using the desired pipe size and approximate flow rate, determine the pressure drop from the appropriate graph.
2. Multiply the pressure drop obtained in step 1 by the viscosity correction factor found in the accompanying table. This is the adjusted pressure drop for all baskets, without filter bags.
3. Add the pressure drop for the bag filter housing.

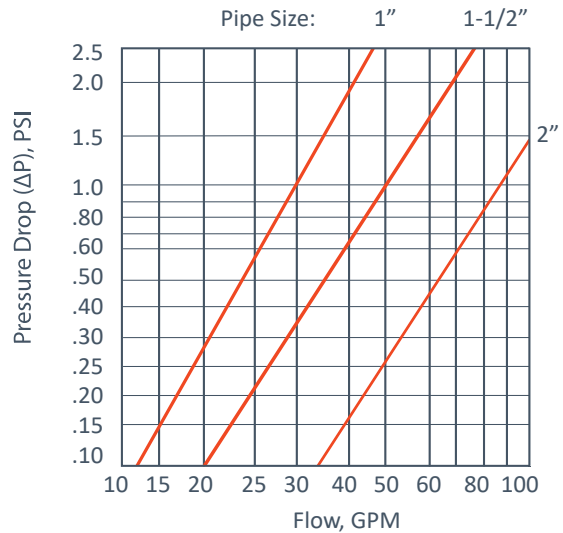

*Based on housing only. Fluid viscosity, bag filter used, and expected dirt loading should be considered when sizing a filter.



Clamp covers on the left and center, eyenut cover on the right.

Filter bags are specified and sold separately.

Model 4-6 accepts bag size #3
Model 4-12 accepts bag size #4

Table with columns for Bag Style and Viscosity (CPS) ranging from 1 (H2O) to 2000. Rows include All Unlined Baskets, 40-Mesh Lined, 60-Mesh Lined, 80-Mesh Lined, 100-Mesh Lined, and 200-Mesh Lined.



Model 4 - Dimensions

COVER TYPES

Eyebut Cover

500 Series with pipe threads

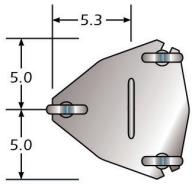

Clamp Cover

Rated 200 PSI with NPT connections

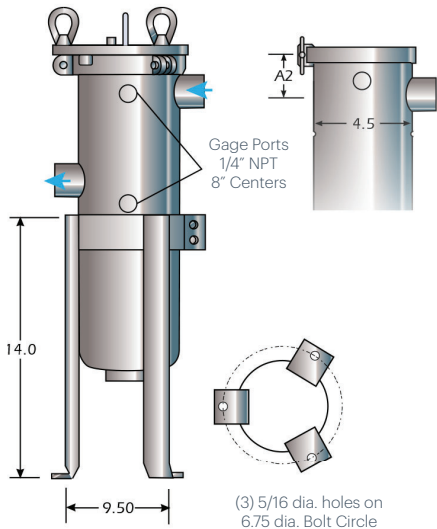
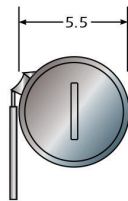

(3) 5/16 dia. holes on 6.75 dia. Bolt Circle

OUTLET STYLES

Threaded NPT Connections

STYLE 1

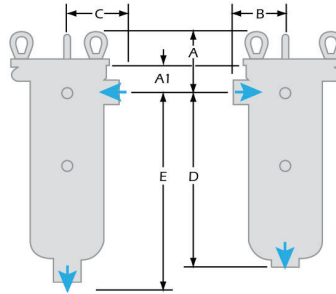

STYLE 2

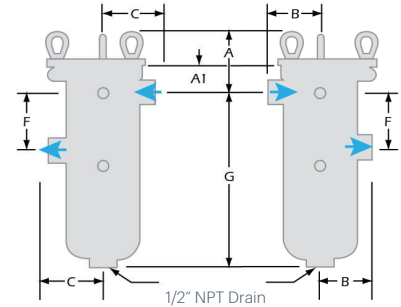

STYLE 3

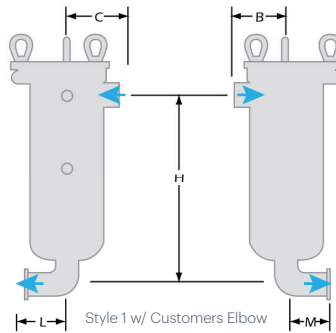

STYLE 4

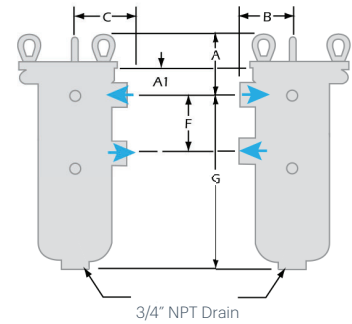

A clearance distance equal to the basket depth must be available above the housing for basket removal. Legs for the Model 4 are optional at an extra cost.

Model Size	Pipe	A	A1	A2	B	C	D	E	F	G	H	L	M
4-6	1	5.5	1.9	2.3	3.5	5.0	10.3	12.0	4.5	10.1	10.9	4.0	2.5
	1 1/4	6.1	2.5	2.9	3.5	5.0	9.7	12.0	4.5	9.4	10.6	4.0	2.9
	1 1/2	6.1	2.5	2.9	3.5	5.0	9.6	12.0	4.5	9.4	10.9	4.0	3.3
	2	6.1	2.5	2.9	3.5	5.0	9.6	12.0	4.5	9.4	11.6	5.0	4.1
4-12	1	5.5	1.9	2.3	3.5	5.0	16.3	18.0	4.5	16.1	16.9	4.0	2.5
	1 1/4	6.1	2.5	2.9	3.5	5.0	15.7	18.0	4.5	15.4	16.6	4.0	2.9
	1 1/2	6.1	2.5	2.9	3.5	5.0	15.6	18.0	4.5	15.4	16.9	4.0	3.3
	2	6.1	2.5	2.9	3.5	5.0	15.6	18.0	4.5	15.4	17.6	5.0	4.1

Dimensions are for reference only and should not be used for hard plumbing. Request a drawing from filters@rosedaleproducts.com



Model 4 Housing Code - How to Order

CONFIGURE YOUR PART NUMBER (EXAMPLE: 4-12-1P-1-500-S-B-S-M40-D-C)

A

MODEL NUMBER

B

HOUSING SIZE

C

PIPE SIZE

D

OUTLET STYLE

E

PRESSURE RATING

F

HOUSING MATERIAL

G

COVER SEAL

H

BASKET SEAL

I

BASKET TYPE

J

BASKET, MEDIA SIZE

K

DISPLACER

L

ASME CODE STAMP

A	MODEL NUMBER	CODE
	EYENUT COVER	4
	CLAMP COVER	LCO4

B	HOUSING SIZE	CODE
	6 INCH	6
	12 INCH	12

C	PIPE SIZE, NPT AND FLANGED ¹	CODE
	1-IN. FEMALE NPT	1P
	1-1/2-IN. FEMALE NPT	1-1/2P
	2-IN. FEMALE NPT	2P

D	OUTLET STYLE	CODE
	BOTTOM	1
	SIDE HIGH	2
	BOTTOM ELBOW	3
	SAME SIDE HIGH	D

E	PRESSURE RATING ¹	CODE
	200 PSI (NPT) (LCO4 ONLY)	200
	500 PSI (NPT)	500

F	HOUSING MATERIAL	CODE
	CARBON STEEL	C
	304 STAINLESS STEEL	S
	316 STAINLESS STEEL	S316

G	COVER SEAL	CODE
	BUNA N	B
	ETHYLENE PROPYLENE	E
	FLUOROELASTOMER	V
COVER SEAL - EYENUT COVER ONLY		CODE
	FEP/PFA	TEV
	PTFE (SOLID WHITE)	TSW

H	BASKET SEAL	CODE
	NO SEAL (WITH BAG TYPE BASKETS)	N
	SEAL REQUIRED (ON STRAINER TYPE BASKETS)	S

I	BASKET TYPE	CODE
	FILTER BAG BASKET, 9/64 PERFORATIONS ²	PB
	STRAINER BASKET, PERFORATED METAL	P
	FILTER BAG BASKET, PERFORATED, MESH LINED ²	BM
	STRAINER BASKET, PERFORATED, MESH LINED W/ SPRING HANDLE	M
	FILTER BAG BASKET, HEAVY WIRE 10 MESH ²	HWM
	FSI/POLYLOC	POLY

J	BASKET, MEDIA SIZE	CODE	
	NO SYMBOL FOR PB BASKET		
	PERFORATION DIAMETERS (P BASKETS)	PERF SIZES	MESH SIZES
		1/4	20
		9/64	40
	MESH SIZES (M AND BM BASKETS)	3/8	60
			80
			100
			200

K	DISPLACER	CODE
	DISPLACER	D

L	ASME CODE STAMP	CODE
	CODE STAMP - EYENUT COVER ONLY	C

- 1.Higher pressure ratings and alternative connections available. Consult factory.
- 2.Filter bags are specified separately.