

**FLUX**



**JUNIORFLUX**

# JUNIORFLUX – THE SMALL POWER PACKAGE

For filling, emptying, transferring or dispensing small amounts of liquid out of carboys, hobbocks, canisters, narrow-necked containers or barrels FLUX now offers a better performance: the new JUNIORFLUX pumps type F 310 and F 314.

The JUNIORFLUX pumps are available in polypropylene (PP) or stainless steel (S), both in version with mechanical seal – Type F 310 – or sealless – Type F 314.

A powerful 230 Watt commutator motor with a 2-speed switch allows sensitive, fast and therefore low-cost and safe filling operations. The motor is built to protection class II, splash-proof and comprises an overload cut-out switch. Another feature is the modern and ergonomically structured design for single-hand operation.

The new JUNIORFLUX pump can be used in almost every field of industry. With a weight of 2 kg and being easy to handle, it may be used wherever small amounts of low flammability liquids, like acids, alkaline solutions, solvents, detergents, etc. must be decanted. Major fields of application are laboratories, chemical store rooms and workshops.

## Special features and benefits:

- high safety factor: powerful 230 Watt motor with built-in overload cut-out switch, double insulated and splash-proof
- 2-speed switch for sensitive filling operations
- ergonomic handle
- version in 230 Volt tested to German VDE and GS specifications
- pump in polypropylen (PP), with mechanical seal or sealless, or in stainless steel 316 Ti (S), sealless
- easy cleaning: outer tube can be removed by hand
- integral clip to suspend the pump
- hook on pump outlet for fixing a hand tap

## Examples of liquids, the JUNIORFLUX pumps can be used for:

**Type F 310 PP and F 314 PP:** acetic acid up to 80 %, ammonia water, boric acid, caustic soda, caustic potash solution, citric acid, formic acid, fruit acids, lactic acid, liquid fertilizers, liquid soap, phosphoric acid, photo developers, distilled water.

**For short periods:** chlorine water, hydrochloric acid, hydrofluoric acid, sulphuric acid.

**Type F 314 S:** acetic acid up to 80 %, ammonia water, caprylic acid, caustic soda, caustic potash solution, fatty acids, lactic acid, methylenechloride, nitric acid up to 40 %, perchloroethylene, trichloroethylene.

A detailed **Resistance Chart** on further liquids is available on request.

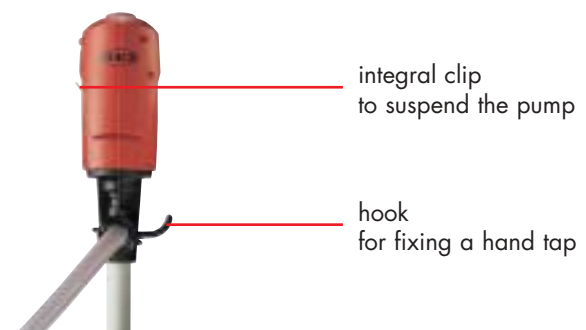
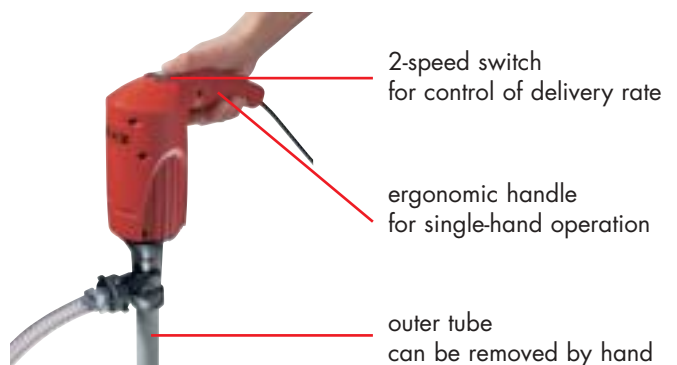



**2-3**

Introduction  
Table of Contents

**4-5**

JUNIORFLUX F 310 PP, with mechanical seal  
JUNIORFLUX F 314 PP, sealless  
JUNIORFLUX F 314 S, sealless

**6-7**

Pump Kit and Accessories  
The Great Range of FLUX Pumps



INNOVATORS IN FLOW TECHNOLOGY

# JUNIORFLUX F 310 PP WITH MECHANICAL SEAL



Type/Curve	F 310 PP-25/19	F 310 PP-32/25
Delivery rate max.	27 l/min	47 l/min
Delivery head max.	5,0 m	6,8 m
Viscosity max.	500 mPas (cP)	500 mPas (cP)
Temperature max.	45 °C	45 °C
Seal type	mechanical seal	mechanical seal
Material (wetted parts)	Polypropylene, ETFE, ceramic oxide/PTFE/carbon, FPM (Viton®), Hastelloy C	
Outer-Ø	25 mm	32 mm
Thread on outlet	G 1 A (BSP 1" male) Hose connections DN 13 and DN 19 included with the pump.	
Motor	Commutator motor 230 Watt, 240, 230, 50 Hz or 110 Volt, 50-60 Hz, double insulated, protection class II, splash-proof to IP 24, with overload cut-out switch, 2-speed switch, 5 m power supply cable with 2-pole plug	
<b>Part No. 230 Volt*/Weight</b>		
Immersion length 500 mm	<b>310 41 005</b> /1,8 kg	<b>310 42 005</b> /1,8 kg
Immersion length 700 mm	<b>310 41 007</b> /2,0 kg	<b>310 42 007</b> /2,0 kg
Immersion length 1000 mm	<b>310 41 010</b> /2,1 kg	<b>310 42 010</b> /2,1 kg
<b>Part No. 240 Volt*/Weight</b>		
Immersion length 500 mm	<b>310 41 405</b> /1,8 kg	<b>310 42 405</b> /1,8 kg
Immersion length 700 mm	<b>310 41 407</b> /2,0 kg	<b>310 42 407</b> /2,0 kg
Immersion length 1000 mm	<b>310 41 410</b> /2,1 kg	<b>310 42 410</b> /2,1 kg
<b>Part No. 110 Volt*/Weight</b>		
Immersion length 500 mm	<b>310 41 205</b> /1,8 kg	<b>310 42 205</b> /1,8 kg
Immersion length 700 mm	<b>310 41 207</b> /2,0 kg	<b>310 42 207</b> /2,0 kg
Immersion length 1000 mm	<b>310 41 210</b> /2,1 kg	<b>310 42 210</b> /2,1 kg

\*tested to German VDE and GS specifications

## Performance Chart

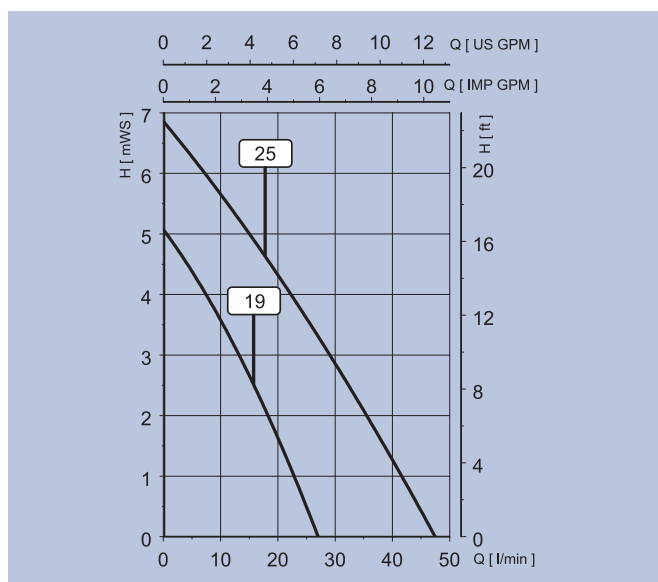

## Dimensions F 310 PP-25/19 and F 310 PP-32/25

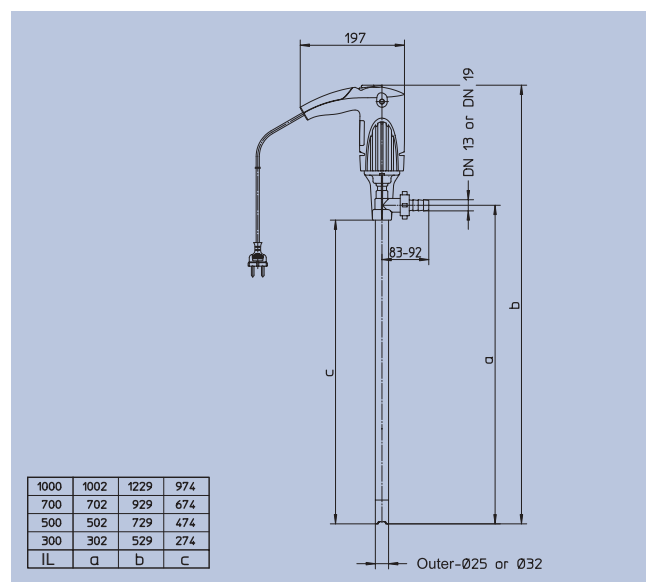

## JUNIORFLUX F 314 PP AND F 314 S SEALLESS



F 314 PP-25/19

F 314 S-28/25

Type/Curve	F 314 PP-25/19	F 314 S-28/25
Delivery rate max.	40 l/min	57 l/min
Delivery head max.	5,2 m	8,5 m
Viscosity max.	500 mPas (cP)	500 mPas (cP)
Temperature max.	45 °C	60 °C
Seal type	sealless	sealless
Material (wetted parts)	Polypropylene, ETFE, PTFE/carbon, Hastelloy C	stainless steel 316 Ti, ETFE, PTFE/carbon
Outer-Ø	25 mm	28 mm
Thread on outlet	G 1 A (BSP 1" male) Hose connections DN 13 and DN 19 included with the pump	G 3/4 A (BSP 3/4" male) Part numbers of hose connections see Accessories Page 6
Motor	Commutator motor 230 Watt, 240, 230, 50 Hz or 110 Volt, 50-60 Hz, double insulated, protection class II, splash-proof to IP 24, with overload cut-out switch, 2-stage switch, 5 m power supply cable with 2-pole plug.	
<b>Part No. 230 Volt*/Weight</b>		
Immersion length 500 mm	<b>314 41 005/1,8 kg</b>	<b>314 21 005/2,8 kg</b>
Immersion length 700 mm	<b>314 41 007/2,0 kg</b>	<b>314 21 007/3,0 kg</b>
Immersion length 1000 mm	<b>314 41 010/2,1 kg</b>	<b>314 21 010/3,2 kg</b>
<b>Part No. 240 Volt*/Weight</b>		
Immersion length 500 mm	<b>314 41 405/1,8 kg</b>	<b>314 21 405/2,8 kg</b>
Immersion length 700 mm	<b>314 41 407/2,0 kg</b>	<b>314 21 407/3,0 kg</b>
Immersion length 1000 mm	<b>314 41 410/2,1 kg</b>	<b>314 21 410/3,2 kg</b>
<b>Part No. 110 Volt*/Weight</b>		
Immersion length 500 mm	<b>314 41 205/1,8 kg</b>	<b>314 21 205/2,8 kg</b>
Immersion length 700 mm	<b>314 41 207/2,0 kg</b>	<b>314 21 207/3,0 kg</b>
Immersion length 1000 mm	<b>314 41 210/2,1 kg</b>	<b>314 21 210/3,2 kg</b>

\*tested to German VDE and GS specifications



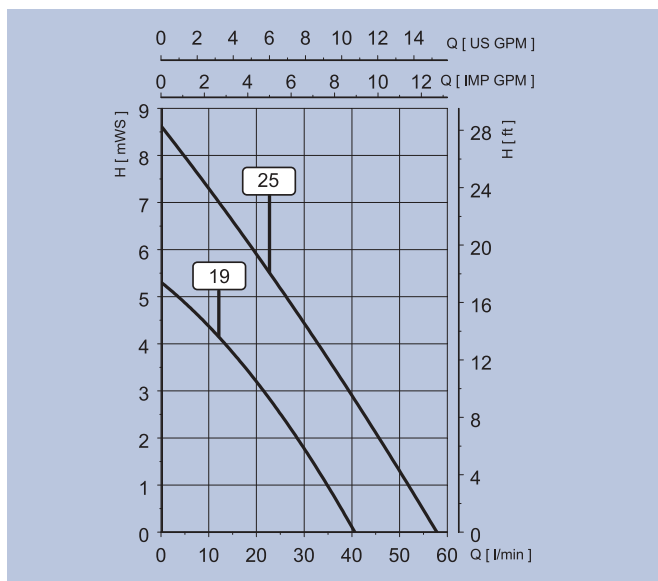

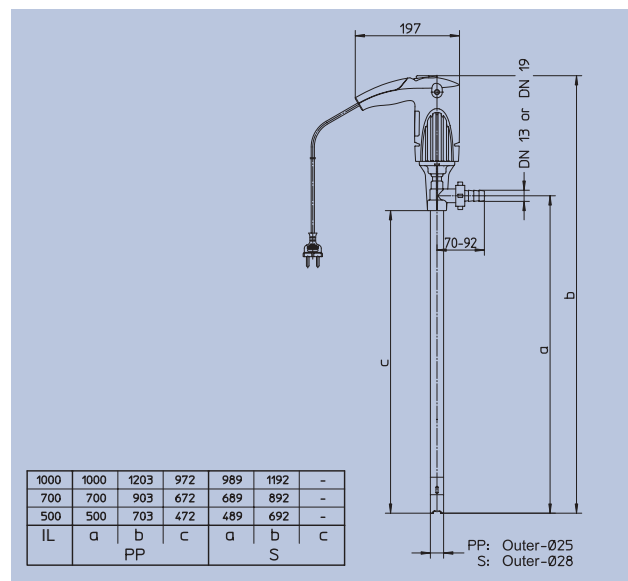

### Performance Chart

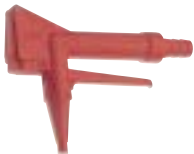

### Dimensions F 314 PP-25/19 and F 314 S-28/25



## PUMP KIT AND ACCESSORIES

	Description	Weight	Part No.
	<b>FLUX Pump Kit JUNIORFLUX</b>	2,40 kg	<b>314 43 007</b>
	consisting of:		
	1 JUNIORFLUX F 314 PP-25/19 230 Volt, 50 Hz, 230 Watt, IP 24, immersion length 700 mm		
	1 Hose connection PP, DN 13		
	1,5 m flexible PVC hose, DN 13		
	2 Hose clips		
	1 Lever tap PP, DN 13		
	<b>Lever Tap PP with small outlet nozzle</b>		
	for filling and dispensing of neutral or corrosive liquids. Material: Polypropylene; seal: FPM (Viton®)		
	Inlet with hose connector DN 13, outlet nozzle Ø 11 mm	0,11 kg	<b>001 13 034</b>
	Inlet with hose connector DN 19, outlet nozzle Ø 20 mm	0,11 kg	<b>001 13 000</b>
	<b>Flexible PVC hose with wire-helix</b>		
	for neutral or corrosive liquids. Operating pressure: max. 2 bar Temperature: max. 60 °C		
	Nominal-Ø DN 13, outer-Ø 18 mm	0,21 kg	<b>001 10 039</b>
	Nominal-Ø DN 19, outer-Ø 27 mm	0,34 kg	<b>001 10 040</b>
	<b>Hose clips</b>		
	in steel, chromium-zinc-plated		
	Clamping range 15 – 18 mm	0,01 kg	<b>959 13 127</b>
	Clamping range 27 – 31 mm	0,01 kg	<b>959 13 071</b>
	<b>Fume gland</b>		
	prevents highly corrosive vapours, which may cause damage to the operator and the environment, from escaping the container.		
	<b>Valve part in polypropylene (PP)</b> with ball valve and union nut		
	for outer-Ø 25 mm	0,11 kg	<b>001 14 309</b>
	for outer-Ø 32 mm	0,11 kg	<b>001 14 313</b>
	<b>Threaded ring in polypropylene (PP), flat seal in FPM</b>		
	Male thread G 2	0,09 kg	<b>001 14 218</b>
	Male thread S 57 x 4	0,09 kg	<b>001 14 224</b>
	<b>Hose connection complete</b>		
	consisting of nut, hose connector and seal		
	<b>with nut G 3/4 female for F 314 S:</b>		
	Nominal-Ø DN 13, material: brass (MS)	0,02 kg	<b>959 04 132</b>
	Nominal-Ø DN 13, material: stainless steel (S)	0,02 kg	<b>959 04 133</b>
	<b>with nut G 1 female for F 310/314 PP:</b>		
Nominal-Ø DN 13 and DN 19, material: Polypropylene (PP)	0,02 kg	<b>959 04 135</b>	

## THE GREAT RANGE OF FLUX PUMPS

# YES!

I am interested in top class pump technology.  
Please send the following catalogues:

- FLUX BARREL AND CONTAINER PUMPS
- FLUX CONTAINER PUMPS
- FLUX HIGH VISCOSITY LIQUID PUMPS
- FLUX CENTRIFUGAL IMMERSION PUMPS
- FLUX AIR-OPERATED DIAPHRAGM PUMPS
- FLUX LIQUID METERS
- FLUX PROCESS CONTROL SYSTEM PCS



THE GREAT RANGE OF FLUX PUMPS

Mr. / Mrs:

Company:

Address:

ZIP / City / Country:

Telephone:

Fax:

eMail:

Please mark with a cross, complete the address and then sent us a fax. Fax number see on the back side!



INNOVATORS IN FLOW TECHNOLOGY

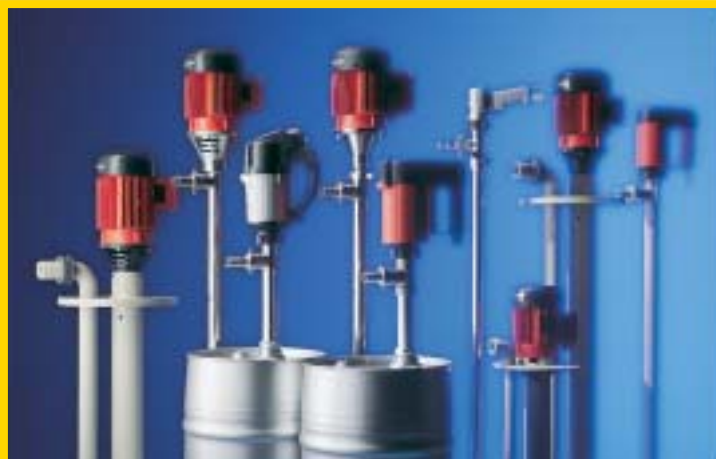

## WORLD OF PUMPS – PUMPS FOR THE WORLD

All around the globe, FLUX is synonymous with top standards in pump technology. Whether it is barrel pumps, high viscosity liquid pumps, vertical centrifugal immersion pumps, air-operated diaphragm pumps, liquid meters, mixers or top class accessories – FLUX with its complete and comprehensive range is always the one to address to. Benefit from our competence. We look forward to hearing from you!



**FLUX-GERÄTE GMBH**

Talweg 12 · D-75433 Maulbronn  
Tel. 070 43/101-0 · Fax 070 43/101-444  
Fax International +49 70 43 / 1 01 -555  
info@flux-pumpen.de · www.flux-pumpen.de